

405™ TS

Getting Started Guide



Quick Start

Here are guidelines for quickly getting up and running with the 405™ TS Microplate Washer:



Install the 405 TS

page 9

Follow instructions for removing shipping hardware and installing the instrument.



Optimize performance

page 37

Review the best practices for optimal performance.



Review the Safety Information

page 85



Copy the 405 TS Operator's Manual to your computer to make it easy to find reference information in the future. The complete operator's manual is delivered on the USB flash drive shipped with the instrument.



Visit us at www.biotek.com.

1171009
Rev C

Contents

Quick Start	1
Notices	4
Global Service and Support	5
BioTek's Customer Resource Center	7
Install the 405 TS	9
Unpack and Inspect the Instrument	10
Remove the Shipping Hardware	10
Setting Up the 405 TS	14
Install Software/Connect to Computer	20
Connect to Power	21
Define Instrument Settings	22
Verify Performance	25
Basic Operation	29
Touch Screen Basics	30
Create or Modify a Protocol	32
Verify Performance	34
Optimize Performance	37
Predefined Protocols Listing	41
Predefined Sample Protocols	42
Operating with the BioStack	47
Use the BioStack	49
Cell Wash	51
Biomagnetic Separation - Magnetic Bead Assays	56
Manifold Stop Screw Adjustment Kit	62
Vacuum Filtration for Filter Plate Assays	64
Changing the Instrument's Settings	68
Washer Settings	69
AutoPrime	70
Maintenance	75
Overview	76
Recommended Maintenance Schedule	77
Daily Maintenance	79
Overnight/Multi-Day Maintenance	79
AutoClean the Washer	80
Removing Protein Residuals and Fungi Growth	82
Safeguards and Troubleshooting	85
Hazards and Precautions	86
CE Mark	89
Electromagnetic Interference and Susceptibility	90
Safety Symbols	92
Troubleshooting	94

Washer Problems	95
Specifications and Part Numbers	103
Physical Specifications	104
Performance Specifications	105
Package Contents	107
Optional Accessories	110
Index	113
Chemical Compatibility	116
405 TS Customer Training Guide	117

Notices

BioTek® Instruments, Inc.

Highland Park, P.O. Box 998

Winooski, Vermont 05404-0998 USA

All Rights Reserved

© 2013, BioTek® Instruments, Incorporated. No part of this publication may be reproduced, transcribed, or transmitted in any form, or by any means electronic or mechanical, including photocopying and recording, for any purpose other than the purchaser's use without written permission of BioTek Instruments, Inc.

Trademarks

BioTek® is a registered trademark and 405™ TS Microplate Washer is a trademark of BioTek Instruments, Inc.

Microsoft®, Internet Explorer®, Windows®, Windows 7, Windows 8, Windows Vista®, Windows XP, and Excel® are either registered trademarks or trademarks of Microsoft Corporation in the United States and/or other countries.

All other trademarks are the property of their respective holders.

Restrictions and Liabilities

Information in this document is subject to change and does not represent a commitment by BioTek Instruments, Inc. Changes made to the information in this document will be incorporated in new editions of the publication. No responsibility is assumed by BioTek for the use or reliability of software or equipment that is not supplied by BioTek or its affiliated dealers.

Global Service and Support

BioTek instrument service and repair is available worldwide at several of BioTek's International Service Centers and in the field at your location. Contact the office nearest you to arrange service or to get answers to your technical questions, call the Technical Assistance Center (TAC) at 802-655-4740 in the US.

BioTek World Headquarters US	BioTek China
Mailing Address: PO Box 998, Highland Park Winsooki, VT 05404-0998 United States	Room 304, Tower D Ocean International Center 62 Middle 4th East Ring Road Chaoyang District Beijing 100024 P.R. China
Service Shipping Address: 15 Tigan Street Winooski, VT 05404 United States	
Phone: (800) 242-4685 Fax: (802) 654-0638	Phone: +86 (10) 85865569 Fax: +86 (10) 85861829
Email: TAC@biotek.com Website: www.biotek.com	Email: infochina@biotek.com Website: www.biotekchina.com.cn

BioTek Germany Service Center & European Coordination Center	BioTek Instruments SAS Bureau de liaison France
Kocherwaldstrasse 34 D-74177 Bad Friedrichshall Germany	50 avenue d'Alsace 68025 Colmar Cedex France
Phone: +49 (0) 71369680 Fax: +49 (0) 7136968111	Phone: +33 (3) 89206329 Fax: +33 (3) 89204379
Email: info@biotek.de Website: www.biotek.de	Email: info@biotek.fr Website: www.biotek.fr

BioTek India	BioTek Singapore
Unit 223, Linkway Estate New Link Road, Malad West Mumbai 400064 India	20 Science Park Road #01-08A Teletech Park Singapore 117674
Phone: +91 (22) 28789966 Fax: +91 (22) 28759944	Phone: +65 65922100 Fax: +65 67772611
Email: biotek@biotek.in Website: www.biotek.in	Email: singapore@biotek.in Website: www.biotek.com

BioTek South Korea	BioTek Switzerland
3F, Gyungnam building, 830-48 Yeoksam-dong, Gangnam-gu Seoul, South Korea (135-936)	Zentrum FanhÖfli 8 6014 Luzern Switzerland
Phone: +82 (0) 2-562-4740 Fax: +82 (0) 2-562-4750	Phone: +41 (41) 2504060 Fax: +41 (41) 2505064
Email: korea@biotek.com Website: www.biotekstruments.co.kr	Email: info@biotek.ch Website: www.biotek.ch

BioTek United Kingdom (UK)
6 Bull Street Potton, Bedfordshire SG19 2NR United Kingdom
Phone: +44 (1767) 262000 Fax: +44 (1767) 262330
Email: info@biotek.uk.com Website: www.biotek.uk.com

BioTek's Customer Resource Center

BioTek's Customer Resource Center (CRC) continues our tradition of superior service and support. After an easy registration process, you can access lots of useful information about your BioTek microplate instrumentation and software. On the secure CRC website, you can:

- Track orders
- Access warranty information, user manuals and software updates
- Download technical and application information
- Maintain equipment inventory (product registration)
- Request service and technical support
- View service history
- And much more!

Register at <https://customer.biotek.com>

Intended Use Statement

- The 405™ TS Microplate Washer provides microplate priming, washing, and dispensing for ELISA™, fluorescence and chemiluminescence immunoassays, cellular and agglutination assays.
- If the instrument has an "IVD" label it may be used for clinical and non-clinical purposes, including research and development. If there is no such label the instrument may only be used for research and development and non-clinical purposes.

Warnings



Operate the instrument on a level, stable surface away from excessive humidity.

When operated in a safe environment, according to the instructions in this document, there are no known hazards associated with the 405 TS. However, the operator should be aware of certain situations that could result in serious injury; these vary depending on the instrument type. See **Hazards** and **Precautions**.

Strict adherence to instrument maintenance and qualification procedures is required to ensure accurate dispense volumes and risk-free operation.

Quality Control

It is considered good laboratory practice to run laboratory samples according to instructions and specific recommendations included in the assay package insert for the test to be conducted. Failure to conduct Quality Control checks could result in erroneous test data.

Warranty and Product Registration

Please take a moment to review the Warranty information that shipped with your product. Please also register your product with BioTek to ensure that you receive important information and updates about the product(s) you have purchased.

You can register online through BioTek's Customer Resource Center (CRC) at www.biotek.com or by calling 888/451-5171 or 802/655-4740.

Repackaging and Shipping

If you need to ship the instrument to BioTek for service or repair, contact BioTek for a Return Materials Authorization (RMA) number and use the original packing materials. Other forms of commercially available packaging are not recommended and can void the warranty. If the original packing materials have been damaged or lost, contact BioTek for replacement packing.

Install the 405 TS

Follow the instructions in this section to install your instrument.

Unpack and Inspect the Instrument	10
Remove the Shipping Hardware	10
Setting Up the 405 TS	14
Install Software/Connect to Computer	20
Connect to Power	21
Define Instrument Settings	22
Verify Performance	25

Unpack and Inspect the Instrument

Important: Save all packaging materials. If you need to ship the instrument or accessories to BioTek for repair or replacement, you must use the original packaging. Using other forms of commercially available packaging is not recommended and can void the warranty. Improper packaging that results in damage to the instrument may lead to additional charges. Refer to the operator's manual for repacking instructions.

Inspect the shipping box, packaging, instrument, and accessories for signs of damage.

If the 405™ TS Microplate Washer is damaged, notify the carrier and your BioTek representative. Keep the shipping cartons and packing material for the carrier's inspection. BioTek will arrange for repair or replacement of your instrument immediately, before the shipping-related claim is settled.

1. Unpack the boxes containing the instrument and other equipment:
 - 405™ TS Microplate Washer and accessories
 - Vacuum Pump and accessories
 - Vacuum Filtration Accessory Kit
2. Place all packing materials back into the shipping boxes for reuse if necessary.

Refer to the Package Contents on page 107 to make sure you have all expected equipment.

Remove the Shipping Hardware

The 405 TS is shipped with a protective manifold shipping bracket. Remove this bracket before using the washer and reinstall it prior to shipping to avoid irreparable damage to the manifold. Failure to remove and reinstall the shipping bracket may void your warranty.

Keep in mind that you must reinstall the shipping hardware and use the original shipping material if it is necessary to return the instrument to BioTek for service or repair.

Remove the manifold shipping bracket

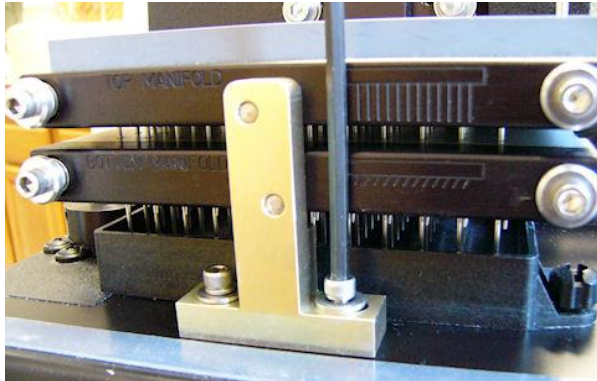

1. Use the 9/64" (3.57 mm) hex wrench to unscrew the cap screws at the base of the shipping bracket and remove it.
2. Slide the bracket towards you and remove.

- Most brackets are black, unlike the one shown here.



3. Store the bracket: mount it on the back panel, on the studs provided.

- Direct Drain Waste System: if you are using the direct drain waste method, wait till later to mount the shipping bracket. For direct drain, an intermediate collection bottle is attached to the washer using the same studs as the shipping bracket. See the Direct Drain Kit instructions.

405 TS with Verify™ Technology

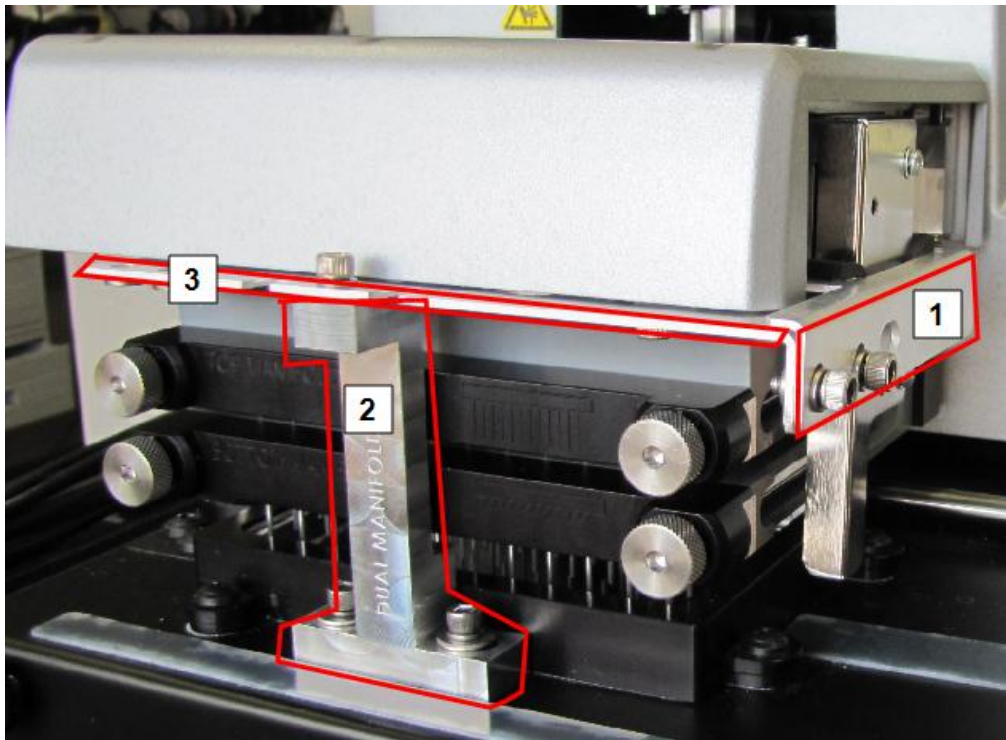

"Q" Models

"Q" Models have three shipping brackets: remove two before powering up, and the last one after start up.



1. Use the 9/64" hex wrench to unscrew the cap screws and remove the bracket on the side of the wash manifold that holds the Verify sensor in place.
2. Remove the large bracket in front holding the wash manifold: Remove the three screws. Slightly lift the manifold(s) to release the bracket from the base, and pull it away from the manifold(s).
3. Set the brackets, screws and washers aside.

Follow instructions to set up the washer, e.g. install the vacuum pump and tubing. Then, perform Step 4, below.

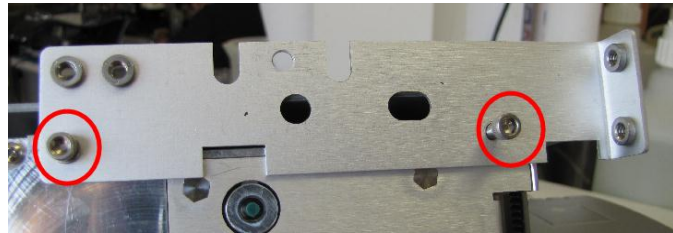

4. When you're ready to power up the instrument, plug it in and turn it on. Release the latch on the left side of the Verify™ sensor unit, and to lift it up to remove the third shipping bracket.
5. For safe keeping, put the cap screws and washers for the two thin brackets in the studs provided on the longest, last-removed bracket.
6. Put the manifold bracket's top screw back in its hole. Save the two longer screws for storing all the brackets on the back of the instrument.

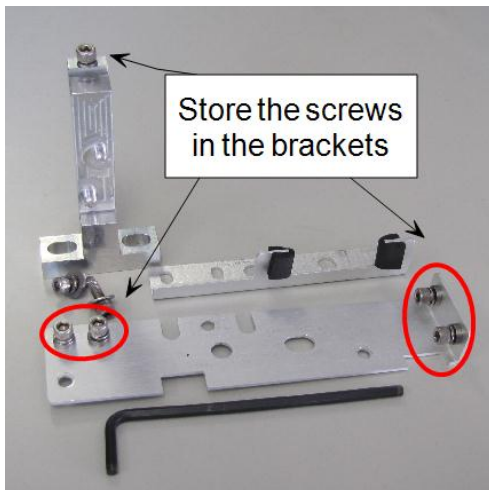



Layer the brackets on top of each other on the studs on the back.

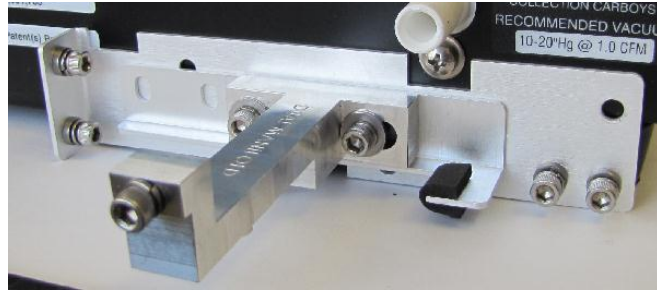

7. Store the brackets: mount them on the back panel on the studs provided. Beginning with the longest (3rd) bracket, layer the brackets on top of each other, and use the longest screws to secure them in place.

Waste System

Caution! Pump Installation. Do not plug the vacuum pump cable into a wall outlet! Use the adapter provided with the pump to connect it to the **Accessory Outlet** on the back of the instrument. This allows the 405 TS to regulate the pump, turning it on and off as specified by the protocol.

When using a standard pump (rather than the high flow pump), set the instrument's **Vacuum Dissipation Delay** to prevent the pump from drawing excess current and blowing the 5-amp fuse. See [Define Instrument Settings](#) on page 22

- Note:** The waste tubes have colored bands that match similarly colored dots next to the inlet/outlet ports on the waste bottle caps to ensure the correct connection of the tubing.

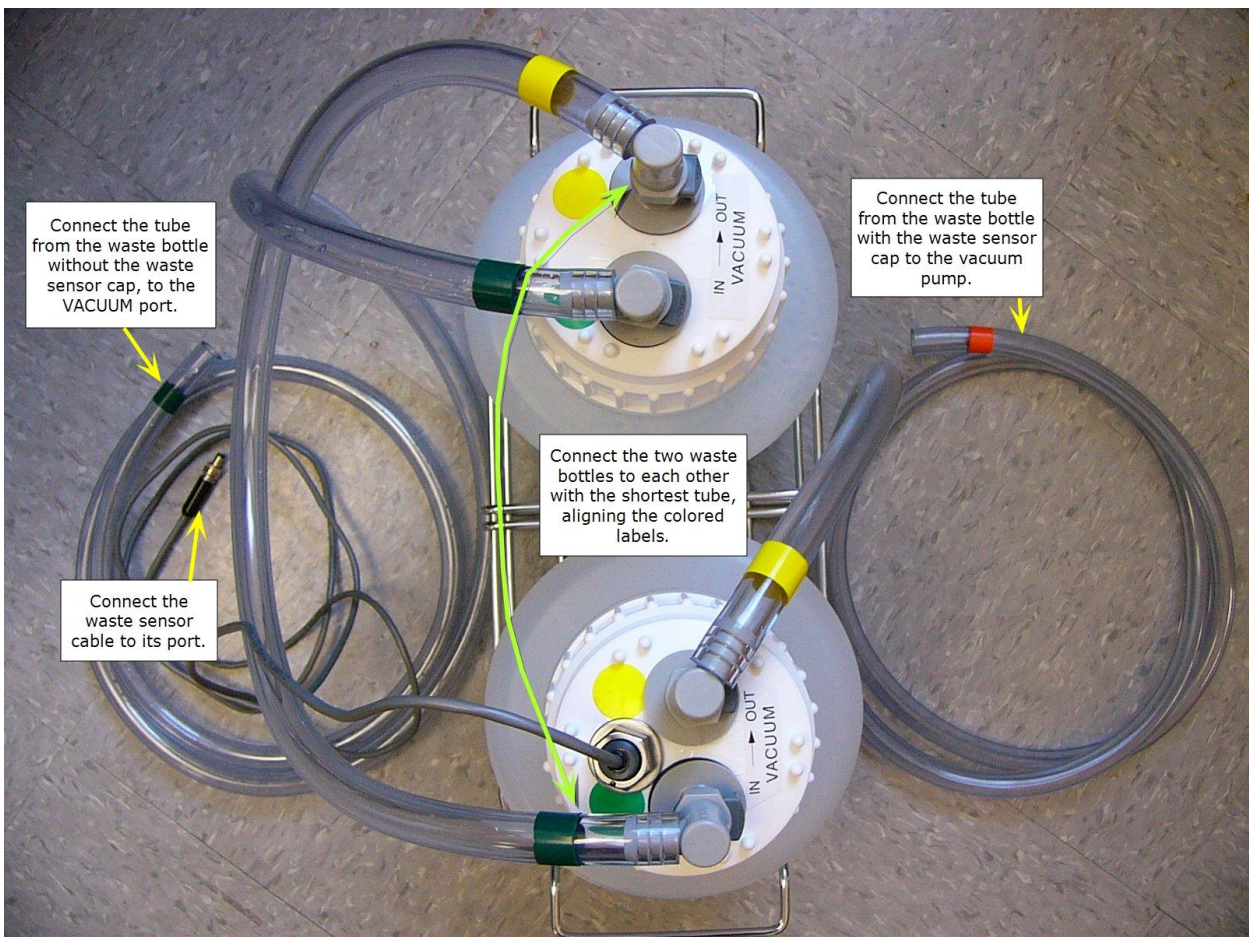

Waste System

Three lengths of tubing are shipped with the waste module:

Tubing:		Connects:
Short tube with yellow and green bands	→	The two waste bottles to each other
Long tube with green bands on both ends	→	Bottle without sensor to vacuum port
Long tube with yellow and orange bands	→	Bottle with waste sensor to the vacuum pump

1. Locate the quick-release caps shipped inside the waste bottles and attach the tubing to them as follows:
 2. Connect the waste bottles to each other using the shortest length of tubing, matching the colored bands on the tubing to colored dots on the caps.
 3. Attach the waste sensor cable to the **Waste Sensor** port on the back of the washer.
 4. Attach the tube from the **waste bottle with the waste sensor** in its cap to the vacuum pump.
 5. Attach the tube from the **waste bottle that does NOT have the waste sensor** in its cap to the **Vacuum** port on the back of the instrument.
 6. **Important!** When installing BioTek's vacuum pump, connect the pump's AC power cable to the vacuum pump **Accessory Outlet** on the back of the instrument. (Use the accessory outlet adapter provided, if applicable.)
 7. Place the waste bottles and vacuum pump on the same horizontal plane as the instrument or below it, such as the floor beneath the work surface. This will help optimize performance.
 8. Make sure the waste bottle's caps are well sealed.
- BioTek strongly recommends installing the vacuum line filter to protect your vacuum pump.

Install the Vacuum Line Filter

The optional vacuum line filter (PN 48294) can be installed halfway between the last waste bottle (overflow bottle) and the vacuum pump.

To do this, cut the tubing and insert the filter, noting the direction of flow. The flow arrow on the filter should point **toward the vacuum pump**.

In the event of a fluid overflow, the filter should prevent the destruction of the vacuum pump's internal components. If an overflow does occur, check the filter for trapped fluid. If fluid is found in the filter, remove the filter and drain using the small white nut on top of the filter. Tighten the white nut and reinstall the filter.

Install the Fluid Supply System

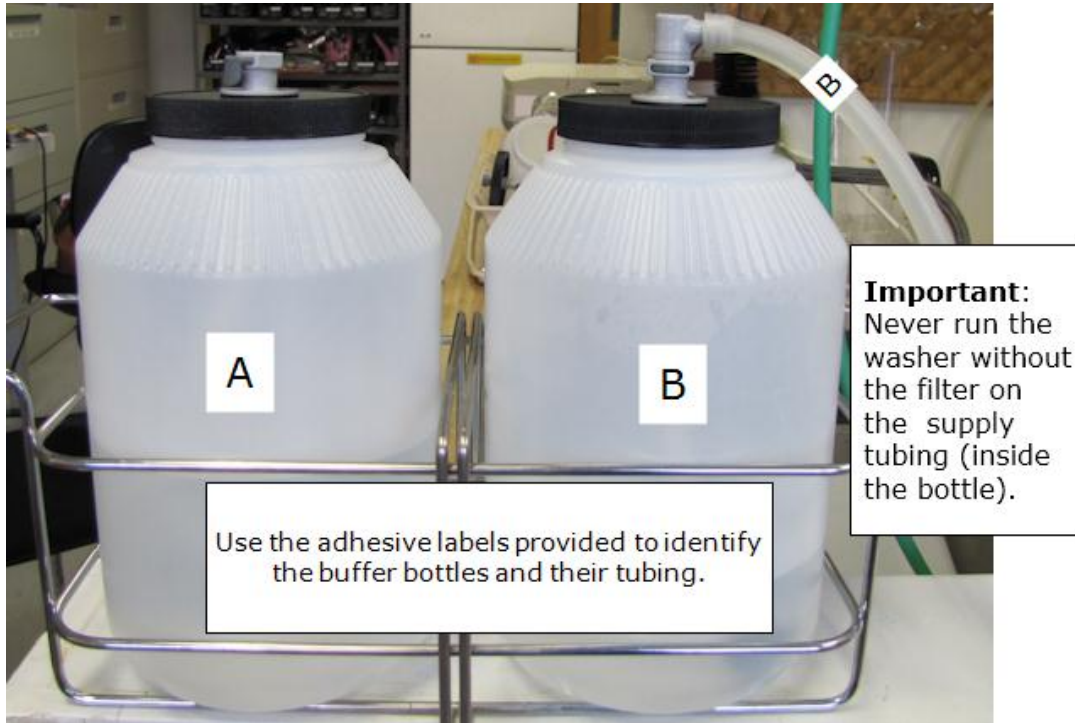

Prepare the supply bottles and tubing:

1. Remove the **Quick Release Connector** from its bag inside the supply bottle and connect it to the raw supply tubing provided.
 - You may need to cut the tubing to the desired length.
2. Snap the connector into the top of the supply bottle.



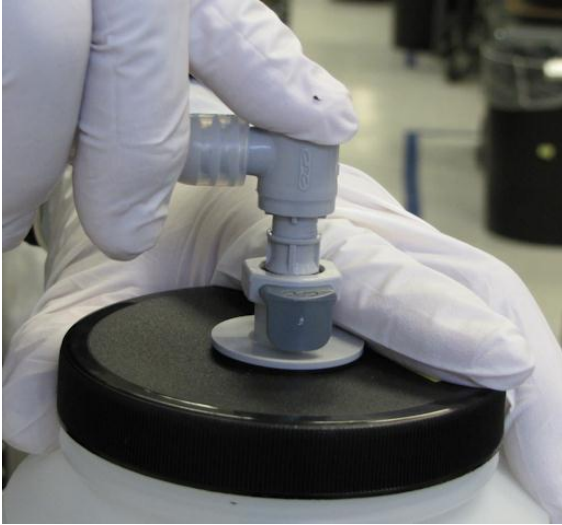

Make sure you hear the connector click!

Attach the labels provided with the washer to identify the buffer bottles.

Note: To avoid spilling fluid when refilling bottles or changing reagents, first release the Quick Connector from the bottle cap, use a paper towel to sop up the few drops in the cap. Then, refill the bottle.

With Buffer Switching (4 Buffers):

1. Place the four supply bottles on the same surface as the instrument.
2. Connect the tubing from one of the supply bottles to the "A" port on the back of the washer.
3. Repeat step 2 with the other three supply bottles for "B," "C," and "D" Buffers.

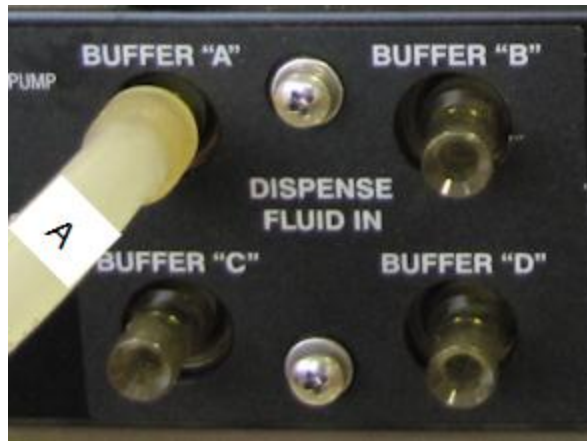

Without Buffer Switching (1 Buffer)

1. Place the supply bottle(s) on the same horizontal plane as the instrument.
2. Connect one the tubes to the **Dispense Fluid In** port.



Install the Microplate Carrier

- Make sure the serial number on the underside of the plate carrier matches the washer's serial number. If the numbers do not match, call BioTek TAC immediately.

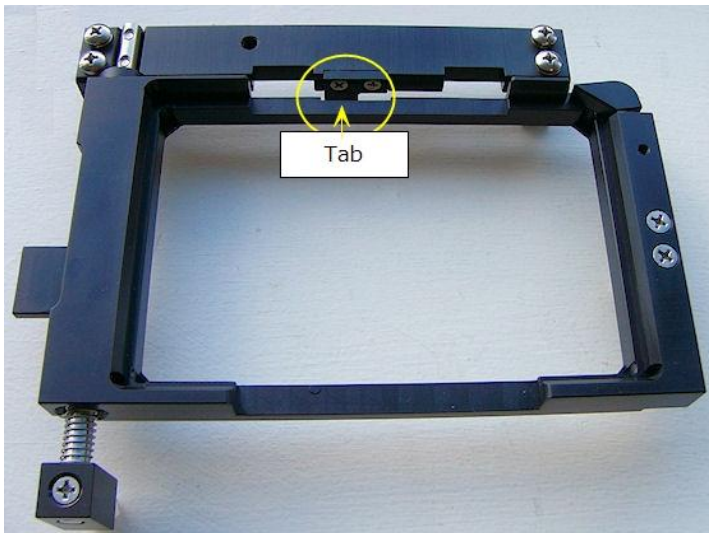

1. Line up the tab on the underside of the carrier with the slot on the carrier transport block.
2. Put the two carrier rail guides onto the transport rail. The tab should sit in the slot.

Final Check

- Verify that the tubing was not crimped during installation.

- Ensure that there are no loose fittings or cable connections.

Attach the Mist Shield

1. Position the mist shield so the gaps align with the thumbscrews. The top rests on the two rubber pads above the manifold.

 Always lift the mist shield straight up, **not** towards you, when removing it.



405 TSs equipped with Verify™ Clog Detection Technology ("Q" models) have a smaller mist shield.



Install Software/Connect to Computer

If you purchased BioTek's Liquid Handling Control™ (LHC) Software to control the 405 TS using your personal computer (PC), please refer to the LHC Installation Guide for complete installation and setup instructions.

Connect to Host Computer

Using the USB cable: Plug one end into the **USB** port labeled **Computer** on the instrument and the other end into an available port on the computer.

- If the computer is connected to the Internet, turn on the instrument. Let Windows® automatically locate and install the necessary USB drivers (follow the online instructions), if applicable or open the link below to download the drivers.
 - Virtual Com Port (VCP) drivers for all Windows operating systems are available at <http://www.ftdichip.com/Drivers/VCP.htm>
 - If the computer is NOT connected to the Internet, install the drivers using the supplied “Virtual USB Com Port” driver software CD.
-
- The Home screen must be displayed for the LHC to communicate with the instrument.



Technical Note: Only one of the two communication ports (COM port) on the instrument can be used at a time. They cannot be used simultaneously. You can use USB to connect the 405 TS to the computer or the RS232 serial port to connect to a BioStack or similar robotic device. But you cannot use both ports simultaneously, i.e. make sure only one cable is plugged in at a time.

Connect to Power

Warning! Power Rating. The 405 TS must be connected to a power receptacle that provides voltage and current within the specified rating for the system. Use of an incompatible power receptacle may produce electrical shock and fire hazards.

Warning! Electrical Grounding. Never use a two-prong plug adapter to connect primary power to the 405 TS. Use of a two-prong adapter disconnects the utility ground, creating a severe shock hazard. Always connect the system power cord directly to a three-prong receptacle with a functional ground.

The 405 TS supports voltage in the range of 100-240 V~ at 50-60 Hz.

1. Plug the power cable into the power cable socket in the rear panel of the 405 TS.
2. Insert the three-prong plug into an appropriate receptacle.

Define Instrument Settings

LHC Users Only



When using the LHC to control the 405 TS, an important first step is defining your instrument's settings. After installing the LHC, you can use the desktop icon or the Windows Start button to launch the LHC:



> **All Programs**> **BioTek**> **Liquid Handling Control**

1. Click the **Name** link on the main page and, if required, select the 405 TS.
2. Specify the COM **Port** used to connect the 405 TS to the computer (use the drop-down list to select the port) and click **Test Communication**.
 - **Pass**: proceed to the next step.
 - **Fail**: check the Com Port setting. See "About Com Ports" in the LHC Help.
3. In the **Target Instrument Settings** dialog that opens, click **Get actual settings now**, and click **OK**.

Standard Vacuum Pump Users

- **Do not** perform this step when using the **High Flow** vacuum pump (PN 7100754). High flow pumps are recommended when aspirating 384-well plates with non-surfactant wash buffers (e.g., pure deionized or distilled water).

Perform this step **ONLY** if you are using the "standard" vacuum pump (PN 7103024): increase the **Vacuum Dissipate Delay** to match your waste container: 1 second per liter. For example, if you have a 10 L waste bottle, set the delay to 10 seconds.

Using the LHC	Using the Touch screen
<ol style="list-style-type: none"> 1. Select Tools>Instrument Utilities. 2. Under General Settings, increase the Vacuum Dissipate Delay to match your waste container: 1 second per liter. 3. Click Send to download this new setting to the instrument. 4. Click Exit to return to the main screen. 	<ol style="list-style-type: none"> 1. Press Instrument>Options 2. Touch the Advanced Settings link. 3. Touch the number field to set the Vacuum Dissipate setting to match your waste container: 1 second per liter. 4. Press the previous button and then Home button.

Setting the Time and Date

Set the time and date to permit the 405 Touch to record "last modified" and "last run" data for each protocol. Only one time and date format is available: DD Month YY. An internal battery keeps the time and date valid when the instrument is turned off.

1. Select **Instrument** from the Home screen, press Next and then, **Other**.
2. Select **Set Time and Date**.
3. Update the time zone, date, and time:
 - Time Zone: Touch the **Select Time Zone** button and select the option that matches your location. GMT = Greenwich Mean Time.
 - Time: Touch the time field to open a number pad. Enter the current hour and minutes to set the 24 hour clock.
 - Date: Touch today's date on the calendar to select it. Press the previous or next arrows next to the month to scroll to the correct month.
4. Press **Save**.





Remember to update the time in accordance with annual time shifts, like Daylight Savings Time, if applicable.

Define Startup Preferences (LHC users only)

You can save enormous time creating protocols by following these steps to define a **New Protocol** template and use it at startup.

Create a protocol template

1.  Click the **New** button or select **File>New**.
2. Click **Name**. Select the 405 TS and define its **Port** and **Settings**.
3. *Highly Recommended:* select the **Plate Type**, fill in the text fields, and add any steps that you want all new protocols to include.
4.  Click **Save** and assign a unique name, e.g. Template.LHC.
5. Select **Tools>Preferences>New Protocol**.
6.  Select the button for **Protocol selected below to use as a template**.
7. Click **selected** and select the protocol you created as a template.

Define startup behavior:

8. After completing the steps above, select the **Startup Options** tab.
9. Select the button for **New Protocol**.
10. Click **OK** to save your new preferences.

Verify Performance

Before using the 405 TS for the first time, verify that it is operating properly.

- When using the LHC, make sure the 405 TS is connected to the PC and both are powered up.
- When running standalone, turn on the 405 TS.

Using the touch screen:

Press **Instrument** and then **Self-Check**.

Using the LHC:

1. Click the **Name** link on the main page and, if required, select the 405 TS.
2. Define the COM **Port** used to connect the 405 TS to the computer and **Test Communication**.
3. In the Target Instrument Settings dialog that opens, click **Get actual settings now**, and click **OK**.
4. Select **Tools>Instrument Utilities**
5. On the General Settings tab, click the Perform **Self-Check** link.

Test results:

- **Pass**: no error message is displayed.
- **Fail**: an error message is displayed. If this happens, note the error code and refer to Troubleshooting on page 94 to determine its cause. If the problem is something you can fix, turn off the instrument, fix the problem, and then turn the instrument back on. Otherwise, contact BioTek's Technical Assistance Center.

The Qualification Chapter in the operator's manual provides Installation and Operational Qualification procedures to perform after the instrument is installed and *before* the instrument is used in a laboratory environment.

- **Important!** Before operating the instrument, review Optimize Performance on page 37. The guidelines include necessary steps to perform before running a protocol, and issues to consider when creating or editing protocols.

Verify the Washer

1. Fill the washer's supply bottle (bottle "A" for buffer switching models) with approximately one liter of deionized water.

LHC	Touch screen
<ol style="list-style-type: none"> 1. Select File > Open. 2. Open the 405 TS and the Prime and Maintenance Protocols folders. Open the applicable "Buffer" folder, and then open W-DAY_RINSE.LHC You <i>may</i> need to reset the Com Port. 3. When ready, click the Run button to prime the tubing and manifold with deionized water. 4. When finished, close the program. 	<ol style="list-style-type: none"> 1. Select Maintenance at the Home screen. 2. Select W-Day_Rinse and press Start. 3. When the protocol is completed, press the Home button.

Run the Verify Test ("Q" Models Only)

If your 405 TS is equipped with BioTek's Verify™ Technology, run the test:

Important! Before running the test:

Make sure the 405 TS is primed and ready to run:

- Fully prime the tubing/system, e.g. run **W-Day Rinse**.
- If necessary, empty waste vessel and tighten waste bottle cap.

Prepare to run the Verify test:

- Fill the supply vessel with at least **100 mL** dH₂O or DI water or buffer solution¹.

Run the Verify test:

Touch screen
<ol style="list-style-type: none"> 1. Select Quick>Verify Manifold and specify the parameters:

¹Do not use highly viscous fluids or wash buffers that are prone to leave significant residue on the plate.

- **Buffer:** Select the bottle to use, if applicable.
 - **Prime:** optionally, prime the manifold tubes to correct for evaporation loss. 40 mL of fluid is dispensed.
 - **%CV Threshold:** optionally, change the %CV to match your lab's standard for QC tests: 5-15%. The default value of 5% is recommended.
2. Press **Start** to run the test.
 3. Assess the results: Verify Results.



Do not discard the **Verify Test Plate**. Reuse it for as long as possible.



405 Touch: BioTek recommends exporting the initial test results and saving them for future reference.

Contact BioTek TAC if any of the tests fail.

Basic Operation

This section introduces the basics of operating the 405 TS. For more detailed and comprehensive instructions, please refer to the operator's manual on the CD shipped with this guide.

Touch Screen Basics	30
Create or Modify a Protocol	32
Verify Performance	34
Optimize Performance	37
Predefined Protocols Listing	41
Predefined Sample Protocols	42
Operating with the BioStack	47
Use the BioStack	49
Cell Wash	51
Biomagnetic Separation - Magnetic Bead Assays	56
Manifold Stop Screw Adjustment Kit	62
Vacuum Filtration for Filter Plate Assays	64
Changing the Instrument's Settings	68
Washer Settings	69
AutoPrime	70

Touch Screen Basics



Home screen

- **Fast, Light Touch:** a light, quick tap on the screen produces the best results. Use your fingertip or a pointing device like a pen tip. The touch screen does **not** support gestures, like swiping and zooming, that are common to smart phones.

Do



Do use your fingertip
(precise selection)

Don't

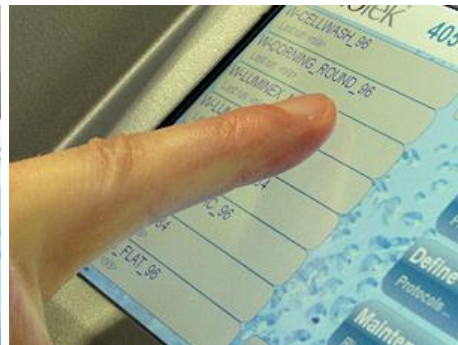

Don't use your finger pad
(uncertain selection)









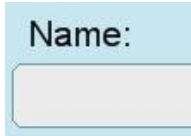

- **Wash Protocols:** Touch a protocol on the **Home** screen to run it. All saved/predefined protocols appear on the Home screen.



Numbers: Touch any field that requires a numeric value to open a field-sensitive number pad. Use the number pad to specify volume, times, and other values. To enter negative numbers use the down (decrement) arrow.



Pick Lists: touch a field with a down arrow to open a pick list to select a value.

	<p>Text: Touch any text field or comments box to open a keyboard. Use the keyboard to name protocols, input runtime prompts, enter comments, etc.</p>
	<p>Scrolling: Press the down or up arrows to scroll a list with more items than fit on the screen.</p>
	<p>Quick access to prime the washer, wash a plate, and when equipped: AutoClean to sonicate the manifold and Verify™ Technology to check for clogged aspirate and dispense tubes.</p>
	<p>To create and modify protocols.</p>
	<p>To run maintenance and quality control protocols.</p>
	<p>To change instrument settings, obtain protocols from a memory stick, etc.</p>
	<p>Home: Press the home button to return to the Home screen at any time.</p>
	<p>Previous: Press the previous button to go to the previous screen.</p>
	<p>Help: To learn more about a screen, press its Help button.</p>
	<p>Green buttons make the 405 TS perform.</p>

Two ways to wash a plate

The 405 TS offers two ways to wash a plate:

- **Quick Wash:** using the touch screen you can wash a plate by defining a few parameters like fluid volume and number of wash cycles and rely on default parameters for the more advanced options. .
- **Run a Wash Protocol:** using either the touch screen or the LHC you can run a wash protocol to wash a plate. You can run a predefined protocol or define your own protocol to specify the optimal parameters for your assay. [See Running Predefined Protocols on page 39.](#)

Create or Modify a Protocol

Select **Define** at the Home screen

To create or edit a protocol:



1. Select **Define** at the Home/Maintenance screen.
2. Press **Create** or highlight the protocol and press **Edit**.



3. **Name:**
 - **New protocols:** Touch the name field to open a keyboard. Enter a unique name for the protocol.
 - **Editing protocols:** Press the **Info** button and touch the name field to change the protocol name. This will create a new copy of the protocol you are editing. Later you can delete the original file, if desired.



4. **Plate Type:**
 - **New protocols:** If needed, touch the plate type field to select a different plate type.
 - **Editing protocols:** Press the **Info** button and touch the **Plate Type** field to change the plate type.

5. **Add/Edit** steps:

- **New protocols:** **Add** a step to the protocol (touch the Add button), select a step and define its parameters.
- **Editing protocols:** Highlight a step and press **Edit** to modify its parameters.
- **Adding steps:** Highlight the **<end of steps>** or a step to be preceded by the new step, and press **Add** and the action button to insert a step.



Copy a similar protocol and then edit it to meet different requirements or to test different parameters.

When editing a protocol, cut and paste steps to move them to the correct position.

- Continue adding or editing steps, as needed.
- Press **Save** to save the protocol. All saved protocols are put on the Home screen for easy retrieval.



Optionally, do a test run to verify the protocol performs as expected. Test Run executes the protocol. Fill vessels with water or disconnect them if you want to preserve reagent.



Especially when creating complex BioStack protocols, use the Validate button to check the order of the protocol steps.

Add protocols to the Home screen

The 405 TS puts all saved protocols on the Home screen for easy retrieval. Create and save a protocol to add it to the Home screen listing.

Remove protocols from the Home screen

All saved protocols appear on the Home screen. To remove a protocol from the Home screen listing:

- Select **Define** at the Home screen.
- Highlight the protocol you want to remove and press **Delete**.

The protocol file will be permanently deleted.

- To delete a locked protocol, first unlock it.



Locked files: you can "unlock" a protocol by replacing it using the Protocol Transfer control. Upload the protocol to a USB stick, make sure "**Lock files**" is disabled and re-transfer the protocol. It will overwrite the existing file.

Change the Plate Type

Edit a protocol to change its plate type:

- Select **Define** at the home screen.
- Highlight the protocol and press **Edit**.
- Press the **Info** button on the step definition screen and touch the **Plate Type** field to change the plate type.

4. Press **OK** to save the change. Press **Save** at the step definition screen to save the protocol.

Empty the priming trough

Perform a Self-Check to empty the priming trough, if necessary: press **Instrument** at the Home screen and press **Self-Check** on the **Current Config** screen.

Verify Performance

Quick>Verify Manifold

BioTek's Verify™ Technology quickly detects clogged aspirate or dispense tubes.

Important! Before running the test:

Make sure the 405 TS is primed and ready to run:

- Fully prime the tubing/system, e.g. run **W-Day Rinse**.
- If necessary, empty waste vessel and tighten waste bottle cap.

Prepare to run the Verify test:

- Fill the supply vessel with at least **100 mL** dH₂O or DI water or buffer solution¹.

Run the Verify test:

Touch screen

1. Select **Quick>Verify Manifold** and specify the parameters:

- **Buffer:** Select the bottle to use, if applicable.
- **Prime:** optionally, prime the manifold tubes to correct for evaporation loss. 40 mL of fluid is dispensed.
- **%CV Threshold:** optionally, change the %CV to match your lab's standard for QC tests: 5-15%. The default value of 5% is recommended.

2. Press **Start** to run the test.
3. Assess the results: Verify Results.



Do not discard the **Verify Test Plate**. Reuse it for as long as possible.

¹Do not use highly viscous fluids or wash buffers that are prone to leave significant residue on the plate.

Frequency:

5 Minutes: Gain complete confidence that your plates will be processed correctly by spending five minutes to run the Verify test before running your assay!

Develop a schedule for running the Verify routine based on the type of wash buffer you are using, how frequently you use the washer, and your maintenance habits:

- **Daily:** When using PBS, protein, and other fluids that easily crystallize and harden, potentially clogging the tubes, run the Verify routine every day and/or after prolonged downtimes to ensure the tubes are not clogged.
- **Weekly:** When using TRIS and other low-salt buffers and when adhering to the recommended maintenance schedule, you can confidently run the Verify routine less frequently, e.g. before new assay runs.

Replace the **Verify Test Plate** (according to the prescribed procedure) if it is damaged, scratched, warped, etc.

For more details: See **About Verify Technology** in the operator's manual.

Handling the Verify Test Plate

The Verify Test Plate ships in its own special box. The plate is labeled with the serial number of the 405 TS that has been calibrated for its use.

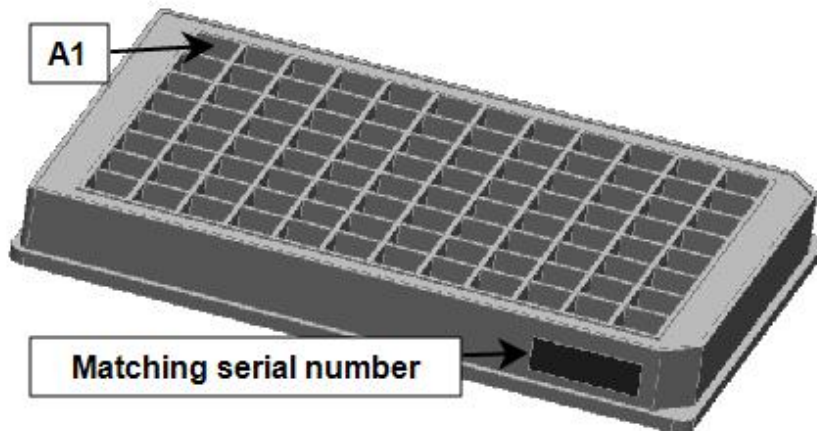

Verify Test Plate

- Well A1 is opposite the chamfered or beveled edges.
- The plate is labeled with the washer's serial number.
- When the plate is on the carrier in the proper orientation, the "Front" label is visible.

Important guidelines:

- Always put the plate on the carrier with well A1 in the back, left corner of the carrier.
- Clean the plate after each use if you are using wash buffer to run the test.
- Fully dry the plate after each use and before putting it back in its foam-lined box.
- Inspect the plate regularly for damage, e.g. scratches, chips, warping.
- Replace the plate when it is damaged. See **Replacement Procedure for Verify Test Plate** in the operator's manual.

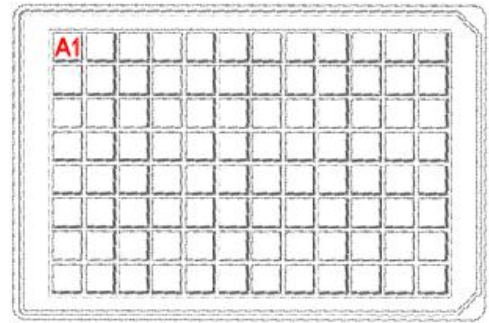

Optimize Performance

Here are some guidelines to ensure optimal performance and to prevent problems.

Keep the devices clean and the tubing wet

The most critical factor for ensuring optimal performance is to adhere to the Recommended Maintenance Schedule on page 77. Enable **AutoPrime** to keep tubes from clogging.

Prime the tubing to remove air bubbles

- See [405 Recommendations for Priming the Washer on the next page](#)

Best Practices

- Fill the supply bottles with sufficient fluid. Never run the 405 TS without the fluid filter installed (on the end of the tubing inside the supply bottle).
- **Note:** To avoid spilling fluid when refilling bottles or changing reagents, first release the Quick Connector from the bottle cap, use a paper towel to sop up the few drops in the cap. Then, refill the bottle.
- Make sure the bottles, solutions, and tubing are clean and do not contain any particles or mold. Solutions that are recycled over several days will grow algae, bacteria, molds, or other undesirable organisms.
- Prime before dispensing. Priming the tubing is the most critical factor in assuring optimal performance.
- Empty the waste bottles and firmly seat the bottles' caps and quick release connectors. To make sure fluid does not back up into the vacuum pump during operation keep the waste sensor cable installed and the waste detection sensor activated. If fluid collects in the overflow bottle, thoroughly rinse the fluid-level switch and bottle.
- Check the external tubing connections for kinks and clogs.
- When equipped with BioTek's Verify™ Technology ("Q" models), before processing your assay plates, take five minutes to run the Verify routine to ensure the manifold tubes are not clogged.
- Put microplates on the carrier with well A1 in the left rear corner as you face the instrument, and firmly seat the plate in the carrier.

405 Recommendations for Priming the Washer

These recommended prime volumes are required to achieve 95% or higher purity when changing wash buffers.

Model	Buffer Switching	One Buffer
405 TS/LS	300	250
HT	300	250

Buffer Switching models have four buffer valves; otherwise, only one reagent bottle may be connected to the washer. For Select models (with Cell Wash (CW) capability), the recommended prime volume is the same with and without Buffer Switching.

Model	Quick Prime	Prime step	
Select	300	Main	Low Flow
		150	150

Manifold Prime: 50 mL is recommended to clear air from the manifold only and to wet the tips. This is recommended before running a protocol to correct fluid loss due to evaporation.

Dead Volume

BioTek's recommended prime volumes are based on purity testing and measured dead volumes. Generally, priming with three times the dead volume assures purity.

Model	Dead Volume
405 TS/LS	108 mL
HT	108 mL
Select	129 mL

For models with buffer switching tubing, dead volume is ± 2 mL additionally.

Running Predefined Protocols

BioTek provides numerous predefined protocols for maintaining the instrument in top condition and for qualifying its performance. Review the **Predefined Protocols on page 41**.

To run a defined protocol:

LHC	Touch screen
<ol style="list-style-type: none">  Select Open and locate the 405 TS folder. Open the 405 TS folder. Find the desired protocol for your instrument model. <p>Important: Be sure to Customize the Predefined Protocols below</p>	<ol style="list-style-type: none"> Touch a protocol on the Home screen to select it. Press Start to run it.

Creating Protocols: Washing, Aspirating and Dispensing Fluid

In addition to the quick routines available from the touch screen's Home screen, you can define and run protocols. Protocols offer more parameters, giving you the ability to fine-tune instrument performance, and perform more complex processing.

Touch Screen Control

See [Create or Modify a Protocol on page 32](#)

Liquid Handling Control™ (LHC) Software



Launch the LHC software to create or modify protocols, see on page 1 on page 1.

LHC Users Only: Customize the Predefined Protocols



BioTek provides predefined protocols for maintenance routines and instrument qualification tests. You can quickly customize the protocols for regular use.



The LHC keeps track of the last-used COM port for an instrument type. For example, when an EL406 runs a protocol, the LHC logs the COM port used and the next time an EL406 is used, the LHC applies the same COM port setting. You can disable this feature by defining your **Ports** preference: select **Tools>Preferences>Ports**.

To correct the COM port for the current protocol, click the [Port](#) link and use the drop-down list to select the correct value. The LHC stores the COM port value in the protocol file.

With the 405 TS connected to and communicating with the host computer (i.e. make sure the instrument is turned on and not busy):

1.  Click the **Open** button, locate the **405 TS** folder and click **Open**.
2. Open the **Maintenance** or other folder and select the desired protocol.
3. [Port](#) Change the COM port if necessary: click [Port](#) and enter the correct value or select from the drop-down list.
4. [Settings](#) Click [Settings](#), which opens the Instrument Settings dialog.
5. Under **Get settings from:** click the [instrument](#) link.
6.  Click **Validate**.
A "Validation successful" message is displayed unless the protocol cannot be run on your instrument.
7.  Save the protocol.

Predefined Protocols Listing

LHC Users: Folders named 4Buffers and 1Buffer contain customized protocols for models with and without Buffer Switching, respectively.

Maintenance Protocols

Daily Maintenance	Description
W-DAY_RINSE	Simple one-step protocol to fully flush the system with water or reagent to keep the manifold tubes clog-free. Defined for use with Buffer A; 500 mL total volume.
W-OVERNIGHT_LOOP	Protocol designed to keep the manifold in a wetted condition overnight or for a long downtime period; manifold tubes are submerged in fluid for 4-hour intervals between primes in this virtually endless loop. Defined to use Buffer A.
W-RINSE_AND_SOAK	Identical to W-DAY_RINSE with one addition, the manifold tubes are submerged and soaked for 5 minutes in the fluid.

Periodic Maintenance	
W-Decontaminate	Two/three stage protocol to decontaminate the washer, first flushing lines with disinfectant and then rinsing them with deionized or distilled water. Buffer switching models flush and then rinse all four lines. Manifold tubes are submerged and soaked for 20 minutes during each pass. Prompts guide the user through the process.
W-LONG_SHUTDOWN	Helps implement the recommended procedure for preparing the instrument for storage. This protocol includes prompts for running disinfectant from Buffer A, then water from Buffer B, and lastly, air through the system - remove bottle from Buffer C valve.
W-PRIME_250/300	Simple prime routine; defined for Buffer valve A only. For LHC only.
PRIME_ALL_BUFFRS	Consecutively primes each of the Buffer Switching valves beginning with D. Designed for use in the annual instrument verification test of the Buffer Switching module.

QC (Quality Control) Protocols

Manifold-Specific	
QC_96_DISP_TEST	Dispense precision test protocol for 96-tube manifold.
QC_96_EVAC_TEST	Evacuation efficiency test protocol for 96-tube manifold.
QC_192_DISP_TEST	Dispense precision test protocol for 192-tube manifold.
QC_192_EVAC_TEST	Evacuation efficiency test protocol for 192-tube manifold.
QC_96_VAC30_TEST	Vacuum filtration evacuation efficiency test for 96-well filter plates and also recommended for use in maintenance procedures.
QC_384_VAC10_TEST	Vacuum filtration evacuation efficiency test for 384-well filter plates and also recommended for use in maintenance procedures.

Predefined Sample Protocols

The "Sample" protocols are provided to facilitate learning. Some samples are model specific.

LHC users: First open the folder that matches your washer model, e.g. 405 Select. You may need to customize the protocols (*as described on page 39*) to match your instrument's settings.

Cell Wash	
W-CELLWASH_96	Cell wash protocol designed to minimize cell layer disturbance in 96-well plates. Aspirate height increased to 50 steps (approx. 6.35 mm above plate carrier) resulting in increased residual, approximately 100 μ L.
W-CELLWASH_384	Cell wash protocol designed to minimize disturbance to cells in 384-well plates. Aspirate height increased to 50 steps (approx. 6.35 mm above plate carrier) will cause increased residual volume but help to preserve the cell monolayer.
Microplate Manufacturers	

W-Corning_ FLAT	Standard wash protocols modified to best position the manifold tubes for dispensing and aspirating to Corning Costar flat-bottomed and round-bottomed wells.
W-Corning_ ROUND	
W-NUNC_ 384	Standard wash protocols modified to best position the manifold tubes for dispensing and aspirating to Nunc® flat-bottomed wells, round-bottomed wells, and 384-well plates.
W-NUNC_ FLAT	
W-NUNC_ ROUND	
Bead Assays - Biomagnetic Separation and Bottom Filtration	
W-Luminex_ MAG_plate_ 96	Biomagnetic separation wash protocols designed for optimal bead recovery in 96-well round- or flat-bottomed plates and 384-well plates when using BioTek's Flat magnets. Begins by soaking the plate for 1 minute to let the beads settle at the bottom of the wells, then performs a 2 cycle wash with 30 second soaks between cycles. Recommendation: Determine Magnet Height Offset on page 61 and apply it for the plate you are using, especially when using 384-well plates.
W-Luminex_ MAG_384	
W-Luminex_ VAC_96	Vacuum filtration wash protocols for Luminex® xMap polystyrene bead assays using filter-bottom plates, 96- and 384-well. Protocol begins with a 5 second bottom aspiration, followed by a 200 µL dispense for 96-well plates and 75 µL dispense for 384-well, and a two cycle 200/75 µL wash.
W-Luminex_ VAC_384	

Wash Step Parameters Table

Minimally, a wash step includes an aspirate step followed by a dispense step. Select and define each option to customize the parameters for your assay.

Option	Description/Values range	Default values
Number of wash cycles:	Each wash cycle first aspirates and then dispenses fluid to and from the plate.	3

Option	Description/Values range	Default values
Aspirate	Vacuum Filtration: Select standard aspiration (Top) or Vac for filtration.	
Filtration Time:	When applicable, specify duration of vacuum filtration in seconds. 5-999	30
Travel Rate:	The rate at which the washer manifold travels down into the wells. The selection range is 1 to 5 for non-cell-based assays, from slowest to fastest. With these rates, the tubes slow their descent as they approach the defined aspirate height (Z Position) to aid complete evacuation of the well.	3
	For delicate, cell-based assays, the range is 1CW (cell wash) to 4CW and 6CW. These rates minimize turbulence in the wells. The tubes descend at a constant rate to the specified height. Rate 6CW creates the least disturbance and performs fastest.	
Delay:	Amount of time the tubes stay at the aspirate height before lifting out of the wells. Define a delay between 0 - 5000 ms. Increasing the delay may improve evacuation of the wells.	0
Positioning:	X- and Y- horizontal axes, Z- height (vertical) axis can be adjusted to improve performance. Default Z-axis for 384-well plates is 22 steps, 2 for 384-well PCR plates.	Z = 29 for 96-well plates; X & Y = 0
Secondary aspirate:	Also called Crosswise Aspiration. First the wells are aspirated using the position defined above. The aspirate tubes rise and then descend to the secondary position to aspirate again.	No
Dispense		
Flow Rate: 96-tube & 192-tube manifolds	The rate at which the fluid is dispensed from the tubes. For cell-based assays, use rate 1 or 2 for gentle washing with the 96-tube manifold only. For normal dispensing, the range is 3-11, 3 is slowest and 11 is fastest.	7

Option	Description/Values range	Default values
Volume:	<p>μL/well dispensed range: 96-tube manifold: 50-3000 192-tube manifold: 25-3000</p>	<p>μL/well: 96= 300 384= 100</p>
Buffer:	Buffer bottle selection. A-D	A
Positioning:	X- and Y- horizontal axes, Z- height (vertical) axis can be adjusted to improve performance. Default Z-axis for 384-well plates is 120 steps; 83 for 384-well PCR plates.	Z = 121 for 96-well plate
Vacuum Delay	Suspends the vacuum pump until a certain volume is dispensed. This feature is critical to cell wash operations. It delays normal aspiration until the specified volume has been dispensed to the wells. The range is 10 to 350 μL/well.	10
Pre-dispense	Quick, small prime to condition the tips before dispensing.	No
Flow Rate:	96-tube & 192-tube manifolds: The range is 3-11, 3 is slowest and 11 is fastest.	9
Volume:	<p>μL/tube dispensed range: 96-tube manifold: 50-3000 192-tube manifold: 25-3000</p>	<p>μL/tube: 96 = 50 192 = 25</p>
Bottom wash	Bottom washing adds an initial wash cycle to the specified number of cycles. Fluid is simultaneously dispensed and aspirated to create cleaning turbulence (at the specified height). The manifold descends to aspirate again and ends with a final dispense to fill the wells.	No
Rate:	Valid range is 3-11. The cell wash rates, 1 CW and 2 CW, which use low-flow tubing, are available but not recommended. Cell wash options are designed for gentle washing, while bottom wash is designed for vigorous washing.	
Wash Volume:	25-3000 μL/well dispense	250

Option	Description/Values range	Default values					
Positioning:	X- and Y- horizontal axes, Z- height (vertical) axis can be adjusted. Repositioning the tubes to harder-to-reach areas of the wells may the improve results.						
Shake	To mix the contents of the plate.	No					
Duration	From one second to one hour.	5 sec.					
Intensity	<table border="1"> <thead> <tr> <th>Intensity</th> <th rowspan="4">Variable cycles through the other levels of intensity</th> </tr> </thead> <tbody> <tr> <td>Slow</td> </tr> <tr> <td>Medium</td> </tr> <tr> <td>Fast</td> </tr> </tbody> </table>	Intensity	Variable cycles through the other levels of intensity	Slow	Medium	Fast	Medium
Intensity	Variable cycles through the other levels of intensity						
Slow							
Medium							
Fast							
Soak	Delays wash for the duration to allow fluids in the plate to steep or incubate.	No					
Duration	From one second to one hour.	30					
Home carrier	To perform the shake or soak in the home position or not. But, the plate carrier is moved home when the total duration of the shake and/or soak exceeds 1 minute. The vacuum pump is turned off in this scenario. Moving the plate home prevents contaminating it with drops from the manifold.	No					
Pre-dispense between cycles	To wet or condition the manifold tubes between cycles, which is only needed after a long soak. Same parameters as regular pre-dispense.	No					
Final Aspirate	A final aspiration is performed to completely evacuate the wells. Same parameters as regular aspirate step.	Yes					
Wash format	Manner of processing large-format plates	Plate					
Sector	Performs the entire wash step on one sector of the plate before it moves to the next sector.						
Plate	Performs each cycle to the entire plate before it starts the next cycle.						

Operating with the BioStack

If you purchased BioTek's BioStack Microplate Stacker to operate with the 405 TS, here is some important information about running it:

LHC Control:

- LHC users: connect both the BioStack and the 405 TS to the computer and control them with the LHC.
- Design protocols that integrate BioStack controls with 405 TS steps. LHC protocols must contain a BioStack loop.
- In the LHC, select **Help>Tutorials**, click **Sections** in the toolbar for a drop-down menu, select **Controlling the Bio-Stack with LHC**. It only takes a couple minutes to complete this interactive demo. It is a great way to learn about the special BioStack features offered with the LHC.

Touch screen Control:

- The Quick Wash option does not function with the BioStack, i.e. the BioStack will not deliver a plate. You must create a protocol to process plates using the BioStack. Touch screen protocols must contain a BioStack loop.
 - You can use the Quick **Prime** option. This is recommended especially prior to processing plates, to remove air from the tubing.
-
- Only one of the 405 TS's communication ports can be used at a time: you can plug in either the USB cable to connect it to the PC or the serial cable to connect it to the BioStack (but not to both at the same time).
-

Install and Align the BioStack:

1. Set up the BioStack according to instructions in your BioStack Operator's Manual to interact with the 405 TS. Connect it to the:
 - Host computer (PC) when using the LHC to control the 405 TS.
 - 405 TS when using the touch screen to control the instrument.
2. Align the BioStack's gripper with the 405 TS's plate carrier:

LHC:	Touch screen:
<ol style="list-style-type: none"> 1. Select Tools> BioStack Utilities. 2. Use the Alignment Utility. Click the Help button for detailed instructions. 	<ol style="list-style-type: none"> 1. At the Home screen, select Instrument>Next>BioStack. 2. Fill the BioStack installed checkbox. 3. Press BioStack Alignment to launch this utility.

3. Set the BioStack operating mode:

LHC:	
	<p>When controlling the BioStack with the instrument, you can choose to run the whole stack or a specific number of plates at runtime: use the BioStack controls on the run screen.</p>
<p>Fill the BioStack checkbox in the main view to enable the BioStack action buttons and use them to design a protocol that delivers and retrieves plates.</p>	

5. **Verify** the setup: perform a protocol with 1 or 2 plates. [See How to define a BioStack protocol on the facing page.](#)

 At the start of the day, power up the BioStack first, and then the 405 TS. **BIOSTACK2WR:** Lift the BioStack's gripper before turning it on.

 Robotics integrators: CAD drawings of the physical dimensions of the 405 TS are available upon request. Contact BioTek customer service.



Technical Note: Only one of the two communication ports (COM port) on the instrument can be used at a time. They cannot be used simultaneously. You can use USB to connect the 405 TS to the computer or the RS232 serial port to connect to a BioStack or similar robotic device. But you cannot use both ports simultaneously, i.e. make sure only one cable is plugged in at a time.

Use the BioStack

How to define a BioStack protocol

- Select Instrument>Next>BioStack and fill the installed checkbox to enable the BioStack steps.

Like the Loop, to use the BioStack put the action steps in a step container. First, add the BioStack step to the protocol and then put the action steps inside the BioStack start (deliver plate) and end (return plate) steps. Here's an example:

1. Highlight a step or the <end of steps> placeholder and press **Add** and then **BioStack**. This adds a start step, BioStack delivers and an end step, BioStack returns plate. The end step is highlighted.
2. Press the desired action button and define the parameters of the steps to be performed on each plate.

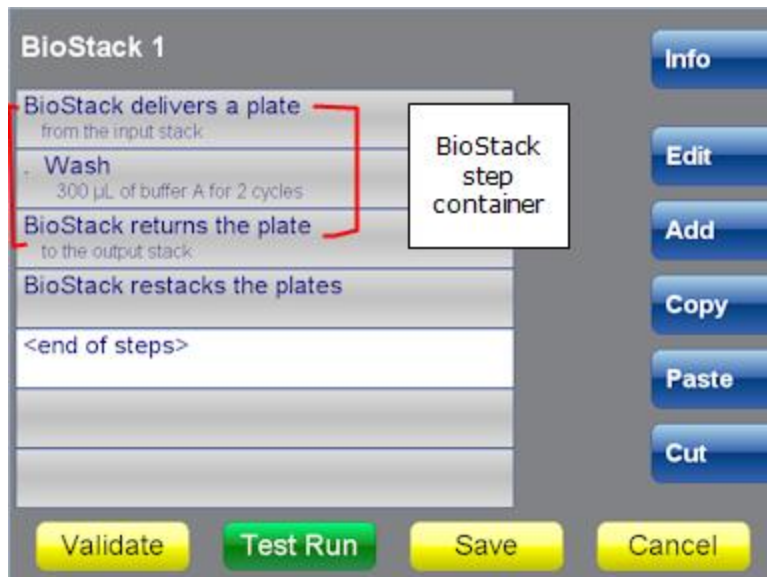

Make sure the steps to be performed on the plates are inside the 'BioStack delivers' and 'BioStack returns' steps.

3. Optionally, highlight the <end of steps> placeholder, press **Add** and add a **Restack** step to move the plates back to the input stack. A **Restack** step must be outside the BioStack step container.
4. When all the protocol steps are defined, click **Validate** to make sure the protocol is correctly designed.
5. Save the protocol.
6. At runtime, define the **Number of plates to process** in the Run Info section of the run screen: enter a specific number or select the "Entire input stack" for processing.

Re-stack plates in the BioStack

After the plates in the input stack have been processed, they are moved to the output stack. The **Restack** step moves them back into the input stack in their original order.

Important: The **Restack** step must be outside the "BioStack" step container and it must follow a container. Only plates previously processed in a BioStack loop can be re-stacked.

Cell Wash

- Not all 405 TS models support cell wash assays. The dual 96-tube wash manifold must be installed.

See how to **Define a Cell Wash Protocol on the next page.**

Low-flow Fluid Path

The 405 TS supports cell-based assays that require the addition and removal of buffer solution without disrupting the cells in the wells of the microplate. Cells are often dislodged when fluid is dispensed at too high a pressure and lost during subsequent aspiration of the fluid from the well unless counter measures are taken. The 405 TS is equipped with a low-flow fluid path that provides a "cell wash" alternative for cell-based assays.

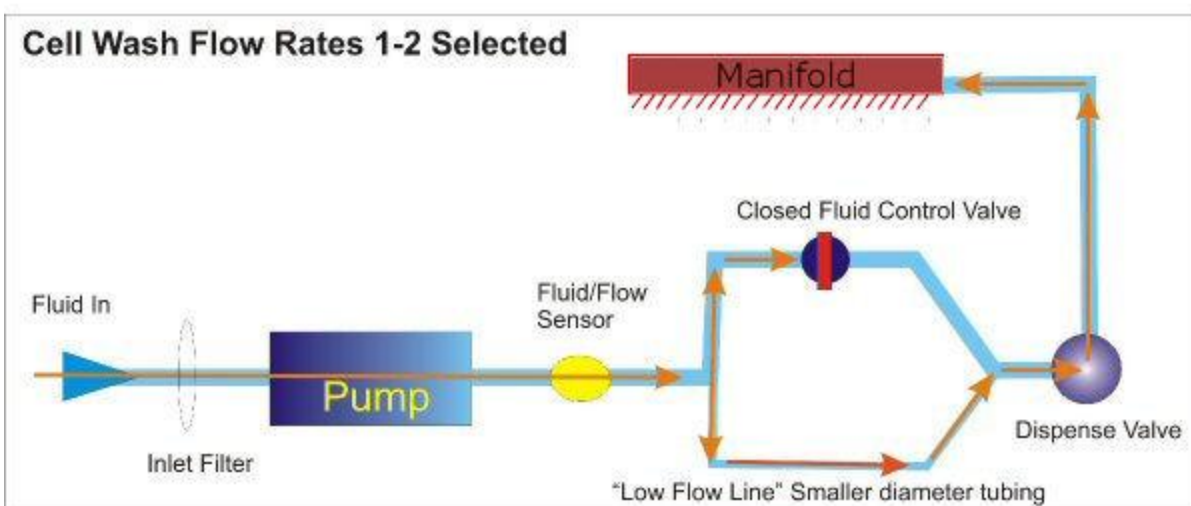
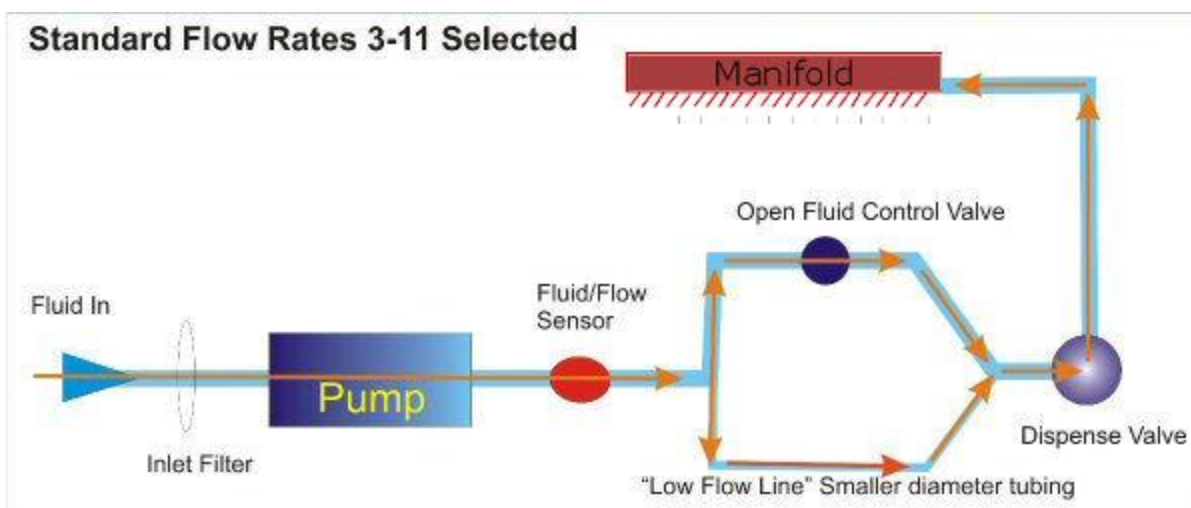

The low-flow tubing is used during a wash step when the Flow Rate is set to 1 or 2. It dispenses fluid to the wells slowly enough to avoid damaging the cells. Note that the low flow line is always open, i.e. some fluid flows through the tubing during normal dispenses. For this reason, priming the low flow tubing is recommended for all Prime steps.

Additional Techniques



Delay Aspiration: Also critical to cell-based assays is delaying aspiration to allow the slower dispense process to finish before beginning fluid removal from the well. This option, offered as part of the dispense step, is called Delay Start of Vacuum.

Adjust the Aspirate Travel Rate and Aspirate Height: when defining the aspirate step select one of the specially designed travel rates that minimize turbulence in the wells. Increase the aspirate height to leave more residual fluid in the wells to protect the cell layer. Also, consider using a secondary aspiration as described in the Cell Wash Strategies described below.

Adjust the Dispense Flow Rate, Height and Position: when defining the dispense step be sure to select one of the special Flow Rates that trigger use of the low-flow tubing, 1 or 2 CW. Also reposition the dispense tubes to aim the fluid at the side of the wells to further minimize turbulence. [See Cell Wash Strategies on the facing page.](#)

Define a Cell Wash Protocol

Adjust the volumes recommended in this procedure to meet your specific needs.

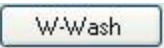
1.  Create a new protocol.
2.  Add a **Prime** step, especially when the lines are empty or when changing fluids.
3.  Add a **Wash** step and define it as you normally would, except with these special parameters:
 - Set the Aspiration **Travel Rate** to **6 CW** and the **Delay** to **0**.
 - Set the Dispense **Flow Rate** to **1** or **2**.
 - Click the Dispense [Advanced Options](#) link and enable the **Delay start of Vacuum** until sufficient fluid has been dispensed. For small dispense volumes, BioTek recommends setting the delay volume to equal your dispense volume.
 - Reposition the dispense tubes to aim fluid at the side of the wells to reduce turbulence and change the aspirate height to increase the amount of residual fluid left in the well to protect the cell layer. [See Cell Wash Strategies on the facing page.](#)

 Be sure to check the parameters for Final Aspiration.

Cell Wash Strategies

To give you a starting point for optimizing your own assays, here are some recommendations for improving your cell wash assays:

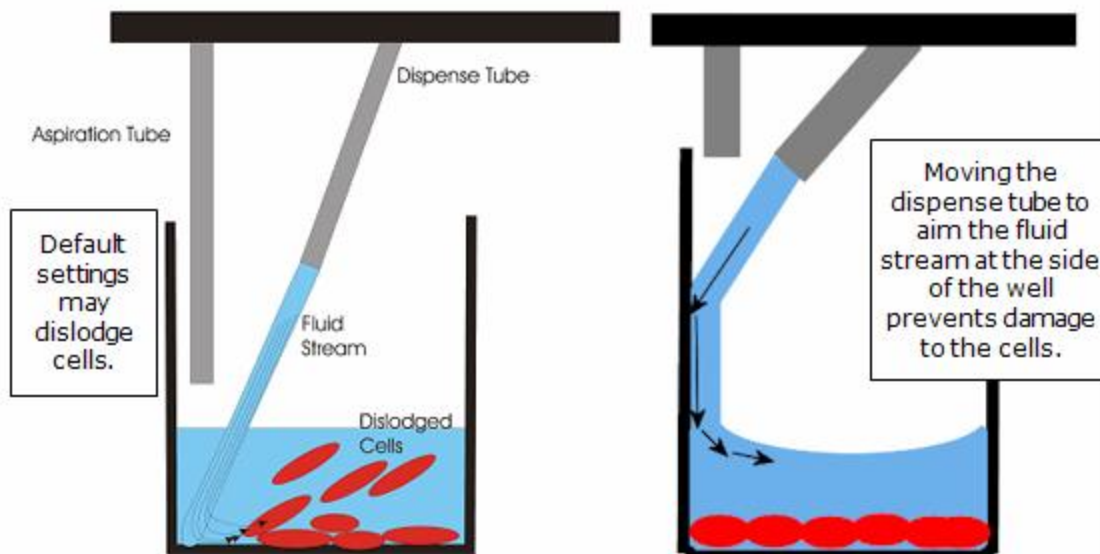

Repositioning the dispense and aspirate tubes helps minimize turbulence in the wells, preserving more cells. Using a standard 96-well Corning Costar plate, best results were achieved with these values:

Dispense Step Settings:
 Z - height = 120 steps
 X - horizontal position = -45
 Y - horizontal position = 0

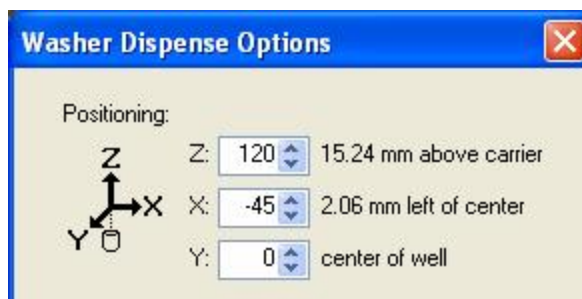

Aspirate Step Settings:

Z = 46 steps

X = 35

Y = 0

Secondary Aspirate:

Z = 80 steps

X = -45

Y = 0

About 40 μ L/well residual fluid is retained using these values.

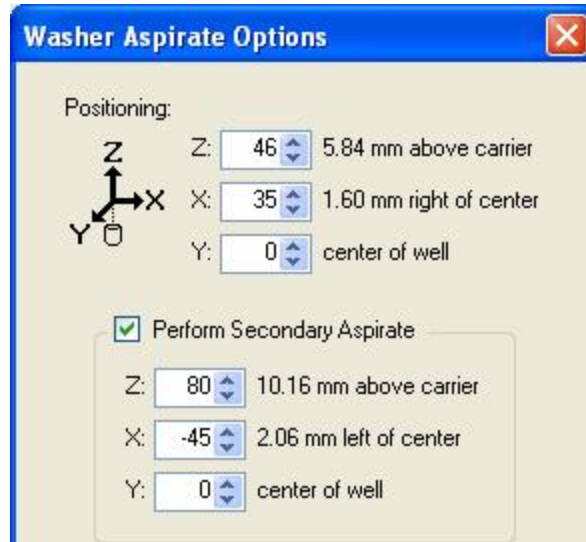

 For loosely adherent cells, the best performance was seen by increasing the aspirate height and using both a standard and secondary (or crosswise) aspiration. Moving the aspirate tubes from one side of the well to the other prevents a fluid stream from forming and dislodging the cells. Increased residual in the well means increased cell retention.

Best practice:

- Use the Align tool to determine the optimal X, Y, and Z axis adjustments needed to best position the manifold above the wells during the wash routine.
- Test the protocol settings by running the protocol using only water and an empty plate before actually running your assay to make sure the fluid stream hits the wells as desired.

Delay Aspiration or Vacuum-On Volume Control**Touch Screen Users: Edit the Wash or Dispense Step>Advanced Options**

During regular plate washing, aspiration and dispensing occurs simultaneously. This allows "overflow" dispensing, because the fluid is aspirated before overflowing the plate. But, the low-flow tubing used in cell wash protocols dispenses fluid so slowly that aspiration must be delayed to allow the fluid to reach the well.

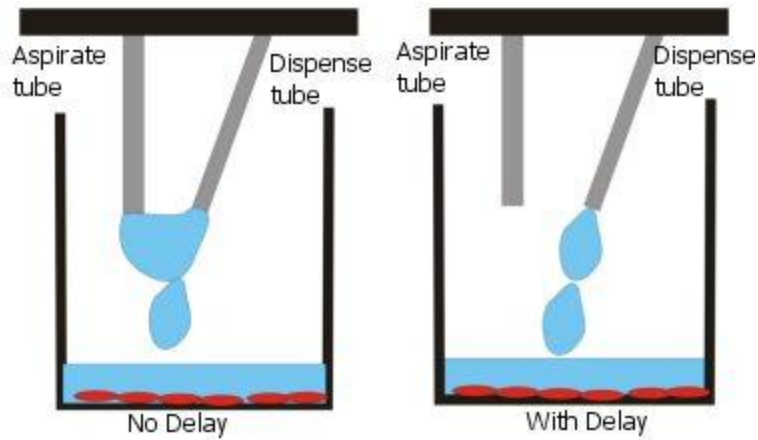

Use this control to turn on the vacuum pump and begin aspiration only after the specified volume is dispensed. For cell wash assays, specify at least 10 μL /well. For small dispense volumes or to disable aspiration for the entire dispense duration, set the vacuum-on volume to equal your dispense volume. Refer also to application notes on the BioTek web site for more information (www.biotek.com).

Biomagnetic Separation - Magnetic Bead Assays

The microplate carrier supports placement of a magnet under the microplate. The magnet induces magnetic beads to settle at the bottom of the wells to help retain them during a wash protocol's aspirate cycle.

The 405 TS supports standard microplates and these magnets available for purchase from BioTek:

Plate Type	Magnet	PN
96-well	96 Flat Magnet	7103016
	96 Ring Magnet	7102216
384-well	384 Flat Magnet	7103017
	384 Ring Magnet	7102215

You can use a different magnet if it fits in the carrier and accommodates your plates. Contact BioTek TAC or visit the Customer Resource Center at www.biotek.com to obtain a drawing of the carrier with its dimensions.

 **Persons with pacemakers/implants should avoid direct contact.** Keep all magnetic media, watches, and sensitive electronic devices away from the magnets. Credit cards, tapes, and disks can be erased in the presence of a magnetic field. Bodily harm [pinching of hands and skin] can result if magnets are not handled correctly. Maintain distance between two or more magnets.

 Take advantage of the sample magnetic-bead protocols shipped onboard the 405 TS. Copy W-Luminex_Mag_Flat_96, for example, and modify the parameters to suit your assay requirements.

Handling and Cleaning the Magnets

For best magnet strength and bead retention, the bottom of the microplate must be as close to the magnet as possible. We recommend using flat-bottom plates with minimal support “webbing” between the sides of the outer wells and the plate skirts.

Handle the magnets with care. Avoid direct contact with the magnet material. Keep loose ferrous material away and do not attempt to disassemble.

The magnet should be stored in a cool, dry environment and should be cleaned with a damp cloth and mild detergent when exposed to harsh solvents. Do not autoclave.

To install the magnet in the proper orientation:

- Flat magnet: place in the plate carrier so the text on the side of the magnet is readable;
- Ring magnet: place in the plate carrier with the small round magnets visible, facing upwards.

Realign the BioStack with the Magnet Installed

Using the magnet increases the effective height of the carrier surface (generally by at least 1 mm). This shift in the plate position requires a comparable adjustment to the BioStack's gripper movement. Realign the BioStack before using it with the magnetic bead assays.

Refer to the BioStack Operator's Manual for detailed instructions of the alignment procedure. To help get you started:

1. Place the magnet in the carrier and a microplate on top of it.
2. Launch the **BioStack Alignment Utility**:

LHC	Touch screen
Tools> BioStack Utilities> Alignment Utility	Instrument>Next> BioStack

3. HOME the BioStack and Begin Realignment.
4. Lower the claw until a 0.050" (1.3 mm) gap between the bottom of the plate and the top of the gripper fingers is achieved and save the gripper position.
5. Put the microplate in the input stack and Verify the alignment.



Remember to realign the BioStack for non-bead assays, when applicable.

Perform Magnetic Bead Assays

For the best results when performing biomagnetic separation assays:

- Use the Manifold Stop Screw Adjustment Kit on page 62, if necessary.
- Realign the BioStack with the Magnet Installed on page 57
- Change the Magnet Height Offset on page 60
- Optimize Magnetic Bead Protocols on the next page

Optimize Magnetic Bead Protocols

Here are some suggestions to consider for optimizing your magnetic bead assays:

- **Plate Type:** Flat-bottom plates are recommended for magnetic bead assays because more of their well surface sits closer to the magnet, resulting in increased magnet strength, than with other plate formats. If you must use round-bottom plates, increase the between-cycle soak time to improve bead separation during processing.
- **Magnet Height Offset:** Deploy this offset to increase the Z-axis or height setting in all processing options to accommodate the increased height of the magnet. See [Determine Magnet Height Offset on page 61](#). Use of this feature may eliminate the need to "Adjust the Aspirate height" described below.
- **Shake/Soak Step:** Begin the protocol with a delay to let the magnetic beads settle. Also, specify a mid-cycle soak to let the beads settle after fluid is dispensed to the plate, e.g. include a 60 second soak before and between cycles.



Include a 1 second Shake in the first step to best position the plate.

- **6CW Aspirate Travel Rate:** select 6CW for the aspirate travel rate. The CW travel rates are designed to minimize disruption to cell layers on the bottom of the well. The same principle applies to magnetic bead assays.
- **Adjust the Aspirate height:** increase the aspirate height setting (Z-axis) which will increase the residual fluid in the wells but also preserve the beads. Good results were obtained when keeping the aspirate height around 1.0 mm above the plate carrier for all but a last Final Aspirate (disabled between cycles).
- **Adjust the Aspirate position:** When using Flat Magnets below, position the aspirate tubes near the sides of the wells (X-axis), if possible, to improve bead retention.
- As always, before running assays, we recommend testing new protocols using deionized or distilled water and a little Tween[®] 20 with the desired microplate and a magnet installed.

Flat Magnets

Use this information about the flat magnets to fine-tune wash protocol settings:

96F Magnet	7103016
384F Magnet	7103017

The 96- and 384-well magnets are structured differently. Their force fields traverse the magnet in opposite directions. Magnetic beads in the wells will be drawn to the center. For the best bead retention, reposition the aspirate tubes in the proper axis:

96-well Flat Magnet PN 7103016

The magnetic force (approx. 6800 Gauss) is distributed in a horizontal pattern, row-wise, across the plate. Magnetic beads are pulled to the center, across the well in flat-bottom plates and to the button in round-bottom plates. Increasing the aspirate height to increase the amount of residual in the well may improve performance.

Aspirate Settings:

Adjust the Y Position to align the aspirate tubes near the well walls, if available. Increase the Aspirate Height (Z axis), leaving more residual volume in the wells.

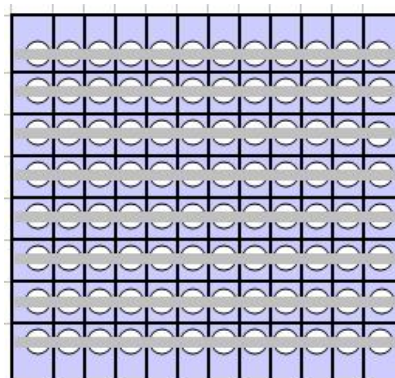

384-well Flat Magnet PN 7103017

The magnetic force (approx. 4300 Gauss) is distributed in a vertical pattern, column-wise, across the plate.

Adjust the X Position to align the aspirate tubes away from the center of the well, near the well walls.

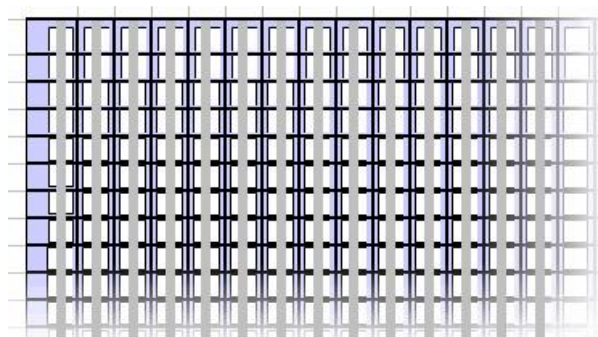

Ring Magnets

Use this information about the VP magnets to fine-tune wash protocol settings:

96 Ring Magnet	7102216
384 Ring Magnet	7102215

96 Ring Magnet

PN: 7102216

This magnetic bead separator uses 329 of VP's 52 MGO magnets (7094 Gauss). The magnets are arranged around each well, pulling the magnetic beads to the bottoms and edges of the wells. Aspirate from the center of the well (the default position), when using this magnet.

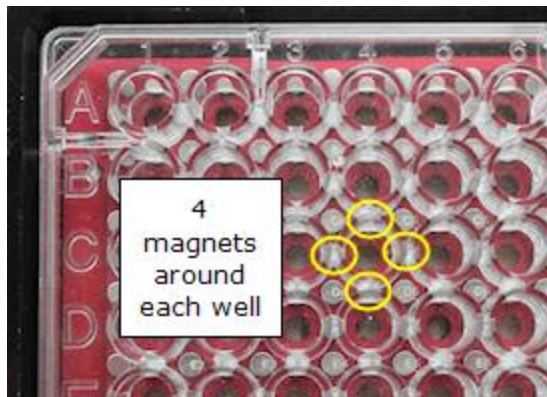
**384 Ring Magnet**

PN: 7102215

This magnetic bead separator uses 425 of VP's 52 MGO magnets (6994 Gauss). The magnets are aligned with the intersections of the wells, pulling the magnetic beads to the bottoms and edges of the wells. Every well is circled by 4 magnets.

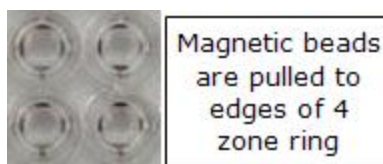



Aspirate from the center of the well (the default position), when using this magnet.

Magnet Height Offset

When performing magnetic bead assays/biomagnetic separation, this offset setting is a real time saver. It increases the height or Z-axis for all processing options to accommodate the increased height of the plate when the magnet is installed.

This setting eliminates the need to modify individual protocol parameters to adjust the dispense and aspirate heights and enables Quick Wash (without adjustments) when the magnet is used. It applies the specified height value as an offset to all relevant steps.

 Custom or non-standard microplates and special adapters for labware may benefit from this setting, too. If a vessel's height has been its only limitation to processing with the 405 TS, i.e. the vessel's geometry permits the manifold tips to successfully address its wells, this setting can be used to simplify protocol development.

 For the best results, measure the height of the plate you are using with the magnet. BioTek has determined that Nunc flat bottom plates are about 3 mm taller than a similar Corning plate, for example.



The "In use" checkbox/option lets you specify and retain a height setting. Set the value once and then use the control to switch it on and off: fill the checkbox (keypad users: say Yes) when using a magnet, empty the checkbox (keypad: No) to disable the offset.

LHC

1. Tools> **Instrument Utilities> General**
2. Fill the **In use** checkbox and set the Magnet Adapter height to the correct offset.
3. Click the **Send** link.

Touch screen

1. **Instrument >Options**
2. Fill the **Magnet in use** checkbox and enter the **Height** offset value. Remove the checkmark to turn off the offset.

Determine Magnet Height Offset

Use a caliper for the best results or another measuring device.

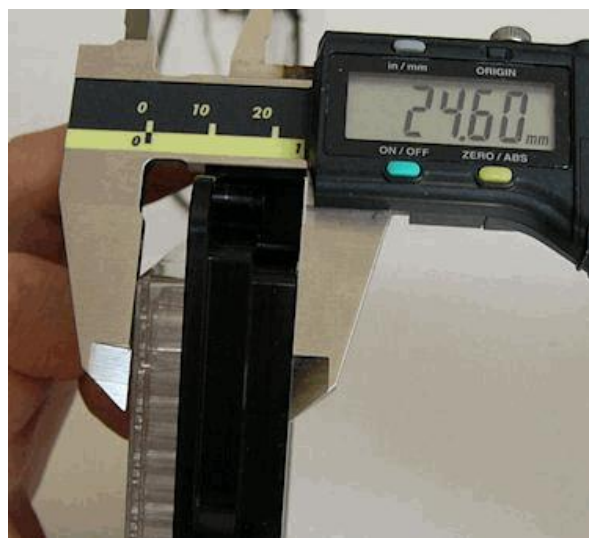

1. Measure the combined height of the plate, magnet, and carrier in millimeters.
2. Measure the plate and the carrier.
3. Calculate the offset: (plate + magnet + carrier) - (plate + carrier) = Magnet Height Offset

1. Remove the carrier from the washer.
2. Put a magnet in the carrier and the type of plate you will be using on top of it.
3. Measure the distance from the bottom of the carrier to the top of the plate in millimeters (mm).
4. Remove the magnet, and measure the plate and carrier combined.
5. Subtract the plate and carrier measurement from the measurement value of the total combined elements. This is the offset value to use.

Example:

24.6 mm = 96-well Corning microplate + 96-well flat magnet + plate carrier

- 22.7 mm = 96-well Corning microplate and plate carrier

1.9 mm = Magnet Height Offset

Manifold Stop Screw Adjustment Kit

For Magnetic Bead Assays and 384-Well PCR Plate Processing

To successfully perform these assays, 405 TS Select and HT models may need to adjust the height of the manifold stop screw. The adjustment kit, PN 1170011, is shipped with instruments with a dual manifold.

The manifold stop screw prevents the bottom manifold from touching the microplate during operation. Sometimes the screw installed at the factory is too tall or too short to permit desired processing:

- a taller screw is needed to support a magnet under the plate for magnetic bead assays
- a shorter screw is needed to support processing of 384-well PCR plates that have a very low profile

Two stop screws can reside in the plate carrier, making it easier to swap between them.

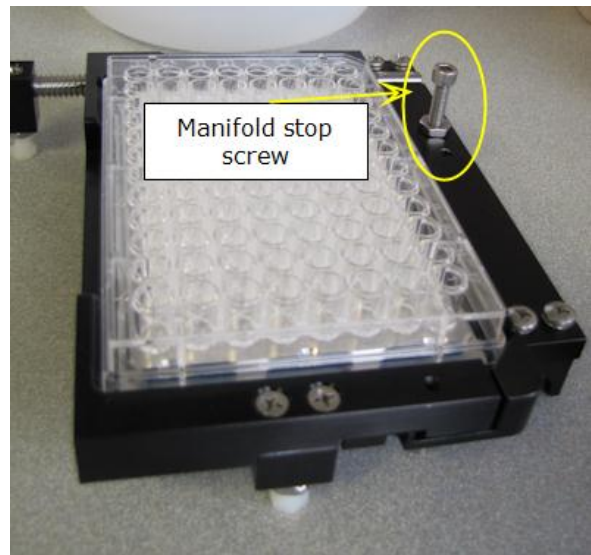

Microplate Carrier

Kit Contents:

- Screw height measurement tool (jig)
- Two stop screws with adjustable nuts and lock washer
- 5/32" Allen (hex) wrench
- Two wrenches - 5/16" and 3/8"



Remove the carrier to perform most of these steps but always perform the measurement steps with the plate carrier installed correctly on the 405 TS.

1. In the carrier's empty hole, insert the taller stop screw when using a magnet or the shorter screw when using PCR plates.

2. Put the magnet and microplate or the 384-PCR plate in the carrier on the instrument. Place the height-measurement tool (or jig) on top of the microplate, with the notched end above the screw.

3. Hold the jig level on top of the microplate and raise or lower the stop screw so its head touches the bottom of the notch.

4. Set the jig aside. Using your fingers, hold the stop screw in place and screw the bottom nut down until it touches the microplate carrier.

5. Using the two supplied wrenches, tighten the bottom nut to secure the screw, then tighten the top nut to fully compress the washer between them. This will lock the nuts in place and allow you to easily remove/replace the screw without affecting its height setting.

6. Verify the height with the jig and repeat steps 3-6 if necessary.

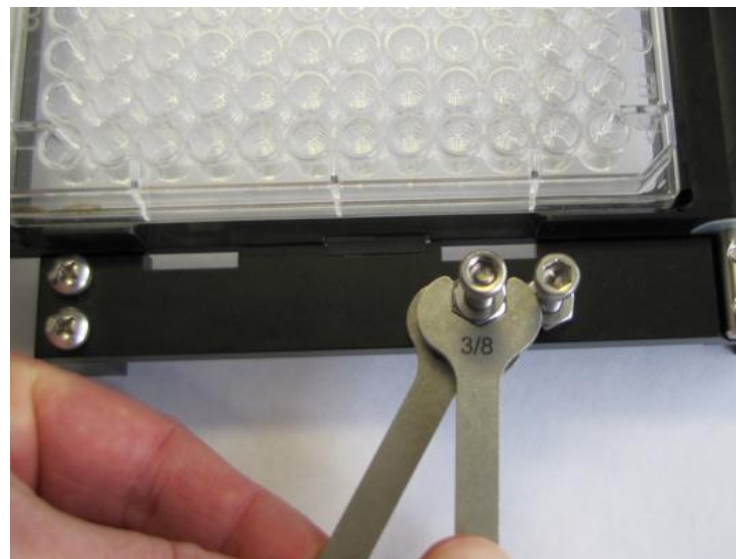
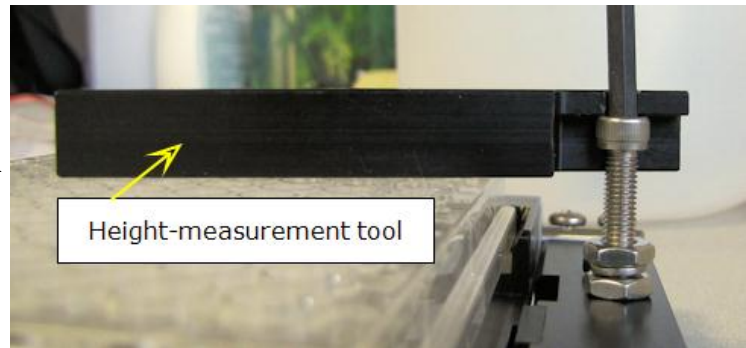

Vacuum Filtration for Filter Plate Assays

With the optional vacuum filtration accessory kit, you can process most standard-size filter-bottom microplates.

- Install the side bracket
- Set up the Vacuum Filtration module
- Enable Vacuum Filtration
- Install Vacuum Filtration Plate Carrier on page 67

 Take advantage of the sample vacuum filtration protocols shipped onboard the 405 TS. Copy W-Luminex_Vac_96, for example, and modify the parameters to suit your assay requirements.

Recommendations for best performance:

Here are some guidelines to achieve the best performance of your filter plate assays:

- Do not use dry filter plates. If dry plates are required by the assay kit instructions, turn off the Vacuum Filtration sensor to avoid process interruptions.
- Shake the plate to suspend the beads before aspiration. Enable the wash cycle option to shake the plate after the dispense and before aspiration. Also consider creating a multi-step protocol that begins by shaking the plate.
- Experiment with the two parameters, aspiration time and vacuum level, to determine the best combination of settings for your assay. Start with a brief time period and low vacuum to avoid lodging the beads in the filter material.
- Maintain consistent vacuum during the process with a tight seal:
 - Use new or defect-free filter plates and make sure they are seated perfectly in the carrier;
 - Make sure all tubing is connected correctly, and leak-free.

Expect to spend some time experimenting with different pressure settings. Follow the filter plate manufacturer's recommendations, if available. Generally, bead assays prefer low pressure and DNA separation assays prefer higher pressure. The best performance in tests at BioTek were seen when the pressure was set to 2.5 inHg.

Create a Vacuum Filtration Protocol

 You may want to begin the protocol with a Shake step to suspend the beads.

LHC:

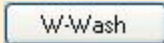
1. Click  (or select File>New).
2. Select the plate type.
3. Specify a **Protocol Name**.
4. Click .
5. Click **Show Wash Options**
6. Fill the checkbox for **Vacuum Filtration** and specify the vacuum duration, **Time**. Optionally, do the same for the **Final Aspirate**.

Touch screen

1. Select **Define>Create**.
2. Touch the **Name** field and enter a unique protocol name. Press OK.
3. Press **Add** and select **Wash** (or **Soak** to begin with a Shake step).
4. Enable **Vacuum Filtration** in the Aspirate step and set the vacuum duration.
5. Define the **Final Aspirate** parameters.

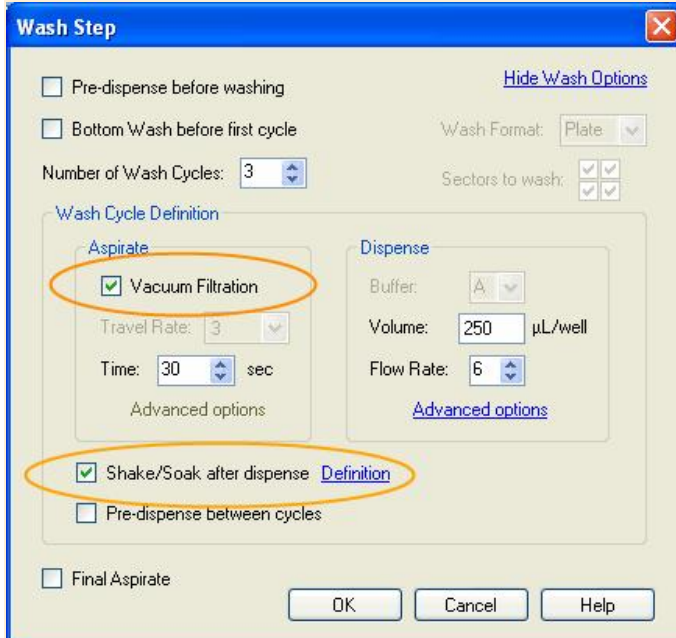

7. Fill the checkbox for **Shake/Soak** and specify the shake duration.

Experiment with different settings to determine the optimal parameters to meet your goals.

- Important: Be sure to change the Plate Carrier setting to match the installed carrier.



Remember to specify the type of aspiration to perform in a [Final Aspirate](#).

Control the Vacuum Level

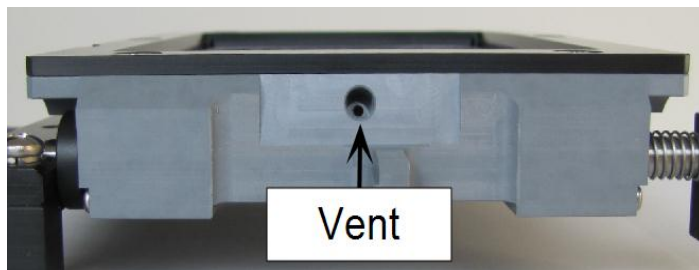
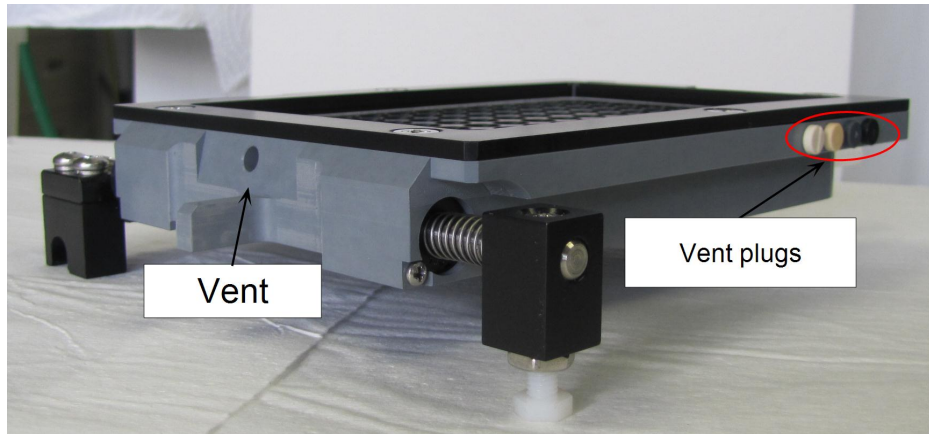

Vent plugs stored on side of carrier

Change the vent plug to control the vacuum level

The vacuum filtration plate carrier has a vent and ships with four vent plugs to vary the vacuum levels:

Plug	Vent Diameter	Vacuum Level	mmHg	kPa
No plug	0.067" (1.70 mm)	Lowest	-32	-4.3
Beige with hole	0.047" (1.19 mm)	Low	-118	-15.7
Gray	0.032" (0.81 mm)	Medium	-187	-24.9
Black	0.020 (0.51 mm)	High	-382	-50.9
Beige (solid)	0.00	Highest	-567	-75.5

Leave the vent open for the least amount of vacuum. Insert one of the plugs to increase vacuum.

- Vacuum pressure is affected by several factors like relative humidity, barometric pressure, and mechanical tolerances, as well as, filter plate pore size

Testing at BioTek confirmed expectations: small pore filter plates and highly viscous fluids require increased vacuum and/or longer aspiration durations to evacuate the wells.

Install Vacuum Filtration Plate Carrier

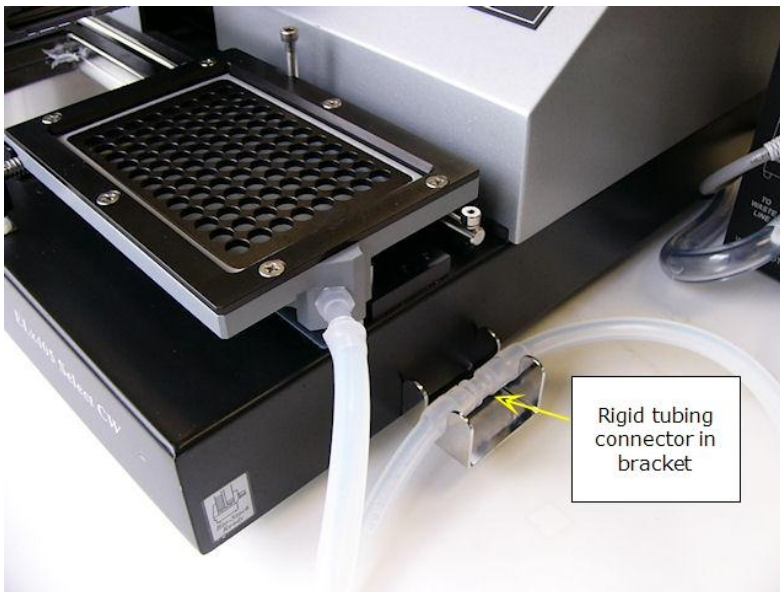

Vacuum Filtration Plate Carrier (and bracket for holding tubing)

1. Locate the longest length of tubing shipped with the module. It is made from two tubes joined by a rigid connector.
2. Connect the shorter end to the special plate carrier for vacuum filtration.
3. Connect the longer end to the control module port labeled **To Vacuum Filtration Carrier**.
4. Tuck the rigid connector into the bracket you installed on the side of the instrument.
5. Change the instrument setting:

LHC	Touch screen
<ol style="list-style-type: none"> 1. Select Tools>Instrument Utilities. 2. For Plate Carrier Selection, select Vacuum Filtration. 	<ol style="list-style-type: none"> 1. Press Instrument > Options 2. Set the Plate Carrier to Vacuum Filtration.

Note: Make sure Vacuum Filtration is "enabled" to select the special plate carrier: **Instrument>Options>Advanced Settings**.

Important: Always set the carrier selection to match the installed hardware, regardless of the type of plate processing you are doing. You can perform a regular wash (non-filter plates) using the vacuum filtration carrier.

Changing the Instrument's Settings

About the Onboard Settings

The instrument's onboard settings dictate its behavior. Certain settings, like Plate Clearance, can improve performance. Other settings are critical to its performance. For example, the manifold setting must match the installed manifold type.

 LHC users: do not confuse the LHC's **Target Instrument Settings** assigned to each protocol with the onboard settings! Review the Help topic: LHC Protocols Explained to learn the distinctions.

To change the onboard settings:

LHC	Touch screen
<ol style="list-style-type: none"> 1. Select Tools>Instrument Utilities 2. Choose the applicable tab and modify settings as desired. 3. Click Send after changing a setting to update the instrument. 	<ol style="list-style-type: none"> 1. Press Instrument>Options for washer settings. 2. Explore the other tabs for more settings.

- When using the LHC to change instrument settings, you may need to reboot the 405 TS **before** controlling it with the touch screen.

Washer Settings

Touch screen: Instrument>Options

Manifold Selection

After physically changing the manifold, tell the 405 TS which manifold is installed:

- **96-tube:** single manifold for 96-well plates only or dual manifolds to process 96- and 384-well plates.
- **192-tube:** only 384-well plates.

Magnet Height Offset

When performing magnetic bead assays/biomagnetic separation, this offset setting is a real time saver. It increases the height or Z-axis for all processing options to accommodate the increased height of the plate when the magnet is installed.

This setting eliminates the need to modify individual protocol parameters to adjust the dispense and aspirate heights and enables Quick Wash (without adjustments) when the magnet is used. It applies the specified height value as an offset to all relevant steps.



Custom or non-standard microplates and special adapters for labware may benefit from this setting, too. If a vessel's height has been its only limitation to processing with the 405 TS, i.e. the vessel's geometry permits the manifold tips to successfully address its wells, this setting can be used to simplify protocol development.

Sensors Enabled

- **Important:** The washer must be primed, tubes filled, prior to a run.
- These sensors cannot detect the depletion of fluid in the supply vessel during a protocol step. Fill the supply bottle(s) with sufficient fluid to fully prime the system and complete the protocol.
- Fluid Detection:** measures the fluid level at the beginning and completion of a wash cycle, dispense and AutoClean step. An error before the run suggests insufficient fluid to begin. An error at the end of the run may indicate that less volume than specified was dispensed.
- Flow Detection:** monitors fluid flow during the run and issues a warning if the pump is interrupted. An error indicates a problem with the pump.
- Filter Vacuum Detection:** built into the vacuum filtration module, this sensor detects errors in the setup of the vacuum filtration system, including disconnected

tubing, loose bottle cap, missing filter plate, non-functioning internal vacuum pump and extremely low vacuum. This sensor is disabled by default.

✔ **Plate Detection:** washers with Verify™ Technology offer this sensor to detect the presence of a microplate on the plate carrier before every protocol run. BioStack users: the sensor checks for the first plate in the stack only.

BioTek recommends keeping the detection systems activated. Exceptions:

- Deactivate the Waste sensor when using BioTek's Direct Drain Waste System.
- When vacuum filtration assays need to be performed at very low vacuum levels, e.g. no plug, but the washer displays an error, deactivate the sensor: LHC - "Filter Vacuum" or Touch screen - "Vac Filtr".
- When running the system using air instead of fluid to dry out the components before shipping or long-term storage, if error messages interrupt the procedure, deactivate the fluid and flow sensors.

AutoPrime

Recommended for optimum performance, AutoPrime keeps the tubing wet in between runs and can be an essential part of your daily maintenance routine.

About AutoPrime

AutoPrime automatically primes the tubing whenever the instrument is idle for a specified time. Keeping the tubes wet prevents clogging and mitigates fluid evaporation at the tips. AutoPrime's submerge feature lets you soak the tubes for extended periods, which is an effective maintenance option.

Specify the Interval and AutoPrime Parameters

AutoPrime runs at the Home screen when the instrument has been idle for a specified interval.

To set the **AutoPrime Interval:**

LHC:	Touch screen:
<ol style="list-style-type: none"> 1. Select Tools>Instrument Utilities> AutoPrime tab. 2. Specify the idle-time interval that will trigger an AutoPrime; up to 24 hours. 3. Enable and define the parameters. Remember to set a Submerge Duration to employ this option. 4. Click Send to transfer the settings to the instrument. 	<ol style="list-style-type: none"> 1. Select Instrument at the Home screen and select AutoPrime. 2. Specify the idle-time interval that will trigger an AutoPrime; up to 24 hours in minutes. 3. Set the Submerge Duration, if desired. 4. Define the AutoPrime parameters: rate, volume, and buffer valve, if applicable.

BioStack

Important: The BioStack must be connected to the 405 TS using the dedicated serial cable shipped with the BioStack and turned on.

- **Get Basecode:** this is good communication test. Check the cabling, and make sure the BioStack is turned on if the basecode version is not revealed.
- **BioStack Alignment:** after setting up the 405 TS and BioStack to interface with each other using the alignment hardware provided and following instructions in the BioStack Operator's Manual, you are ready to use this alignment utility to tell the BioStack precisely where to place and retrieve microplates.

BioStack Alignment Utility

Follow the detailed procedure in the BioStack Operator's Manual to use this alignment utility to precisely align the BioStack's gripper with the microplate carrier: First install the alignment hardware, correctly position the instruments in their respective aligning plates, and connect the instruments with the dedicated serial cable before attempting to align the gripper with the washer.

Begin by pressing **Home** to enable the alignment and step up and down buttons. When the gripper appears to be correctly positioned, Save (the) Position and proceed with the **Verify** procedure.

Press the previous button to exit the screen.

Get protocols from a memory stick - USB drive

Important: Put the protocols you want to transfer to the washer in a folder called **Protocols**. The 405 Touch expects to find a Protocols folder on the memory stick.

You can exchange 405 TS protocols with other users, copy protocols from one washer to another, or obtain sample protocols from BioTek's website using a USB stick:

1. Insert the memory stick into the USB port on top of the washer.
2. Select **Instrument>Next>Other** from the Home screen.
3. Press **Transfer Protocols**.
4. Choose the **File Source: USB** to copy protocols from it to the washer. (Conversely, choose **Internal** to copy protocols to the flash drive to share them with another instrument.)
5. Optionally, apply the **Lock files** option to prevent users from changing the protocols.
6. Select files individually by highlighting them (touch) or transfer all protocols simultaneously.



Locked files: you can "unlock" a protocol by replacing it using the Protocol Transfer control. Upload the protocol to a USB stick, make sure "**Lock files**" is disabled and re-transfer the protocol. It will overwrite the existing file.

Watch a training video

The 405 TS offers a simple video viewer to show short videos from BioTek. The video player is useful only for BioTek-provided videos with restricted frame speeds and the Windows file format: .wmv.

1. Insert the USB flash drive containing the video file into the USB port.
2. Select **Instrument>Next>Other** from the Home screen.

3. Press **Show Video**.
4. Highlight the .wmv file and press **Select**.

Maintenance

Regular maintenance is required to achieve optimal performance with the 405 TS. This section provides guidelines and instructions for basic daily maintenance and the Recommended Maintenance Schedule. Find comprehensive instructions for performing regular maintenance in the operator's manual.

Overview	76
Recommended Maintenance Schedule	77
Daily Maintenance	79
Overnight/Multi-Day Maintenance	79
AutoClean the Washer	80
Removing Protein Residuals and Fungi Growth	82

Overview

A **Preventive Maintenance (PM)** regimen for the 405 TS includes rinsing and soaking the fluid path and cleaning and/or autoclaving the various components. The level of maintenance required to keep the instrument performing as expected is dependent on several factors, including the type of fluid dispensed, the frequency of use, and the work habits employed.

The Recommended Maintenance Schedule on the facing page summarizes BioTek's recommended maintenance tasks, and indicates approximately how often each task should be performed. Daily and periodic routines and minimal guidelines for frequency are listed. Beyond that, it is difficult for BioTek to recommend a fixed frequency for each task to be performed. The frequency of conducting these tasks must be based on the risk and performance factors of your assays.

Develop a maintenance schedule for your 405 TS based on the characteristics of the fluids used and the activity level. Here are some guidelines for each component:

Washer

- When using fluids prone to dry and harden quickly, the washer's dispense and aspirate tubes can clog quickly, and must be rinsed frequently and cleaned regularly. Run **AutoClean** ultrasonic cleaning regularly, when available.
- If the washer will be idle for several hours or days at a time, soak the tubes to keep them in a "wetted" state. Enable **AutoPrime** if the washer is idle for more than 3 hours.
- Wash solutions affect the rinse frequency. If the solution does **not** contain surfactant, consider rinsing (or running **AutoPrime**) at least once an hour.

Recommended Maintenance Schedule

The schedule recommends preventive maintenance tasks, the frequency with which each task should be performed, and the predefined onboard Maintenance program that should be run (if applicable). [See Recommended Maintenance Schedule on the facing page.](#)

- It is important to note that the risk and performance factors associated with your assays may require that some or all of the procedures be performed more frequently than suggested in this schedule.

Recommended Maintenance Schedule

Tasks	Frequency				
	Daily	Overnight/ Multi-Day	Weekly	Periodic/ Monthly	Before storage/ shipment
Run W-DAY_RINSE	✓	✓			
Run AutoPrime	✓				
Run W-OVERNIGHT_LOOP		✓			
Run W-RINSE_AND_SOAK		✓			
Run Verify™ clog detection test	✓				
Run AutoClean				✓	✓
Components					
Remove protein residuals and fungi growth, (if necessary)	✓		✓	✓	
Check/empty waste bottles	✓				✓
Clean bottles				✓	✓
Clean plate carrier system			✓		✓
Clean washer manifold				✓	✓
Clean aspirate and dispense tubes				✓	✓
Clean exterior surfaces and mist shield			✓		
Clean fluid inlet filter				✓	✓
Clean vacuum filtration system				✓	✓
Clean the Verify™ level sensor				✓	✓
Decontaminate					

Tasks	Frequency				
	Daily	Overnight/ Multi-Day	Weekly	Periodic/ Monthly	Before storage/ shipment
Decontaminate external surfaces				✓	✓
Run W-DECONTAMINATE				✓	✓
Decontaminate vacuum filtration system				✓	
Prepare for Storage or Shipment					
Run W-LONG_SHUTDOWN					✓
Replace/Repair Components					
Replace the Verify Test Plate	As Needed				

Daily Maintenance

Daily maintenance involves flushing the washer with an appropriate reagent or deionized water throughout the day. Routine rinsing helps to prevent the aspirate and dispense tubes from clogging between runs. Flushing the devices with deionized water is recommended at the end of the day for most applications.

The recommended **rinsing frequency** depends on the solutions currently in use:

- When a solution containing surfactant is used throughout the day, perform the rinsing procedure when the device is idle for more than 3 hours.
- When the solution does **not** contain surfactant, consider rinsing at least once an hour.

Run this protocol and enable **AutoPrime** to satisfy the daily maintenance requirements:

- W-DAY_RINSE

Make sure the supply bottles contain sufficient rinse solution and that the waste bottles are empty before running the protocols.



Also see the additional maintenance procedures required when dispensing protein solutions: Removing Protein Residuals and Fungi Growth on page 82.

AutoPrime

AutoPrime automatically conditions the dispense tubes, priming them with the specified volume, after a user-specified amount of idle time.

- Press the **STOP** button to interrupt the AutoPrime routine when it is underway.
- Any interaction with the instrument via the touch screen or the LHC resets the interval clock.

Overnight/Multi-Day Maintenance

Overnight/multi-day maintenance involves flushing all solutions out of the instrument, and then periodically rinsing and soaking the tubes to keep them moist. Here are three recommendations for accomplishing the task. Employ the method that best suits your work flow:

Overnight Loop

To keep the wash manifolds in a wetted condition, you can run these predefined protocols to soak the tubes for several hours at a time:

- **W-OVERNIGHT_LOOP**: requires the washer to remain turned on.
- **W-RINSE_AND_SOAK**: alternatively, run this protocol and turn off the instrument after the soak begins. The tubes will soak in the priming trough until the instrument is turned on again.

AutoClean the Washer

Some models of the 405 TS feature BioTek's Ultrasonic Advantage™ for easy and thorough cleaning of the wash manifold. Instruments with AutoClean capability are easily identified by the stainless steel priming reservoir built into the instrument's base, under the wash manifold.

 **Warning!** Ultrasonic energy is present in the cleaning reservoir when the AutoClean program is running. Do not put your fingers in the bath! Ultrasonic energy can harm human tissue.

- **Important!** Ensure there is adequate room in the waste bottle and sufficient volume in the supply bottle **before** running AutoClean!

 **Tip:** Detergent such as Terg-A-Zyme® added to deionized water in the supply bottle helps to break down the water's surface tension and enhances the cleaning process. Terg-A-Zyme also contains protease enzyme for assimilating proteinaceous residue such as bovine serum albumin (BSA).

About AutoClean

BioTek's **Ultrasonic Advantage™** is a built-in ultrasonic cleaner that provides enhanced maintenance capabilities by using ultrasonic pulses in a water bath to clean the manifold tubes. Ultrasonic energy causes cavitation forces within the water bath, which in turn cause tiny vapor bubbles to be created. The formation and subsequent collapse of these bubbles is the mechanism that cleans the manifold tubes submerged in the bath.

The cleaner consists of a stainless steel reservoir with an ultrasonic transducer bonded to the bottom of the reservoir. The reservoir is mounted under the washer manifold and also functions as the priming trough.

- Do not try to remove the ultrasonic cleaner! Only BioTek authorized service personnel should remove the ultrasonic cleaner for maintenance or repair.

While the program is running, the ultrasonic cleaner will pulse on and off approximately every ten seconds, and you will hear a periodic hissing sound that indicates the ultrasonic energy is present.

- Not all 405 TS models are equipped with this feature.

Quick Clean

A the Home screen select **Quick>Sonicate Manifold**

Take advantage of the 405 TS's "Ultrasonic Advantage" to make sure the manifold tubes are clean and clog-free.

1. Fill the "Clean Buffer" bottle with detergent or an appropriate solution for your assay. The 405 TS primes the system with 300 mL/305 mL for CW models and fills the trough with 93 mL for the sonicator. Buffer Switching models: connect it to the specified valve.
2. Set the desired duration to soak the tubes and run the sonicator.
3. Fill the "Rinse Buffer" bottle with at least 305 mL of deionized or distilled water and/or with a wash buffer to leave the instrument primed and ready for use. Buffer Switching models: connect it to the specified valve.
4. When you're ready, press **Start**.



Warning! Ultrasonic energy is present in the cleaning reservoir when the AutoClean program is running. Do not put your fingers in the bath! Ultrasonic energy can harm human tissue.

- **Important!** Ensure there is adequate room in the waste bottle and sufficient volume in the supply bottle **before** running AutoClean!

Submerge and Shutdown

An overnight/multi-day maintenance option for soaking the tips and turning off the instrument for overnight and weekend maintenance.

You can soak the 405 TS dispense manifolds by filling the priming troughs and turning off the instrument after the soak begins. The tubes will soak in the priming troughs until the instrument is turned on again.

1. Run **W-RINSE_AND_SOAK**.
2. When the wash manifold is submerged, turn off the instrument.
5. Run a System Self-Test to empty the washer's priming trough when restarting the instrument.

Removing Protein Residuals and Fungi Growth

 Important! Solutions containing proteins, such as bovine serum albumin (BSA), will compromise the 405 TS's performance over time unless a strict maintenance regime is adhered to. Do not use isopropyl alcohol to flush out BSA.

When using protein solutions or similar fluids, BioTek recommends performing the following additional Maintenance procedures to thoroughly flush out protein particles and other contaminants from the fluid path.

Daily Practice with buffer or deionized water:

If the 405 TS will be idle between plates for longer than 45 minutes, flush the proteins:

1. Fill a supply bottle with deionized water. Connect the bottle to the washer. (Buffer valve "A" for Buffer Switching models)
2. Run the W-DAY_RINSE protocol.
3. Enable AutoPrime for 60-minute intervals.

At the end of the day:

1. Fill a supply bottle with deionized water. Connect the bottle to the washer (Buffer valve "A" for Buffer Switching models).
2. Run the W-DAY_RINSE protocol three times.
3. Perform your regular Overnight/Multi-Day Maintenance routine.

Weekly or As Needed use NaOH and HCl to remove proteins:

1. Flush the system with 0.1-0.5 N* NaOH (sodium hydroxide), followed by neutralization with an equivalent normality (0.1-0.5 N) of HCl (hydrochloride).
2. Rinse well with deionized water to remove the HCl.
3. Run the applicable DAY_RINSE protocol three times with deionized water if you plan to use the device immediately.

- * N = Normal solution, which contains 1 'gram equivalent weight' (gEW) of solute per liter of solution. The gram equivalent weight is equal to the molecular weight expressed as grams divided by the 'valency' of the solute.

Alternatively use an Enzyme-Active Detergent:

1. Mix an enzyme-active detergent according to the manufacturer's directions to fill a four-liter supply bottle. Connect the bottle to the washer's Buffer valve A. Connect a bottle of deionized or distilled water to Buffer valve B to rinse the tubing.
2. Run the **W-DECONTAMINATE** protocol, as appropriate.
3. Respond to the **Delay** message, "Connect a bottle of water...", leave the detergent bottle connected and when ready, press **Continue**.
4. When the protocol is completed, connect a bottle containing four liters of deionized water and run W-DAY_RINSE three times to flush the system.

Clean the Buffer Bottle Filter

Periodically clean the buffer bottle filter (PN 01310):

- Perform this task when the buffer bottle is empty or over a sink to catch spillage.

1. Open the buffer bottle and lift the cap and its tubing up and out of the bottle.
2. Remove the fluid filter at the bottom of the tubing.
3. Wash the filter with hot water and a soft-bristled brush, if necessary.
4. Rinse the filter and reinstall it.





Safeguards and Troubleshooting

This section lists warnings and precautions that must be taken when operating the 405 TS. It also includes guidelines for error recovery and troubleshooting performance problems.

Hazards and Precautions	86
CE Mark	89
Electromagnetic Interference and Susceptibility	90
Safety Symbols	92
Troubleshooting	94
Washer Problems	95

Hazards and Precautions

Hazards

The following hazards are provided to help avoid injury:



Warning! Power Rating. The instrument's power supply or power cord must be connected to a power receptacle that provides voltage and current within the specified rating for the system. Use of an incompatible power receptacle may produce electrical shock and fire hazards.

Warning! Electrical Grounding. Never use a two-prong plug adapter to connect primary power to the external power supply. Use of a two-prong adapter disconnects the utility ground, creating a severe shock hazard. Always connect the power cord directly to an appropriate receptacle with a functional ground.

Warning! Service. Only qualified technical personnel should perform service procedures on internal components.

Warning! Accessories. Only accessories which meet the manufacturer's specifications shall be used with the instrument.

Warning! Lubricants. Do not apply lubricants to the microplate carrier or carrier track. Lubricant on the carrier mechanism will attract dust and other particles, which may obstruct the carrier path and cause the instrument to produce an error.

Warning! Liquids. Avoid spilling liquids on the instrument; fluid seepage into internal components creates a potential for shock hazard or instrument damage. If a spill occurs while a program is running, abort the program and turn the instrument off. Wipe up all spills immediately. Do not operate the instrument if internal components have been exposed to fluid.

Warning! Unspecified Use. Failure to operate this equipment according to the guidelines and safeguards specified in this manual could result in a hazardous condition.

Warning! Direct Drain Waste. If installed, the direct drain waste system pumps waste fluids from the washer directly into a sink or tank, and, potentially into public waste water systems. Because the waste may be a biohazard, you must ensure that you are in compliance with your local or national government's laws regarding safe disposal of the waste.

Warning! Ultrasonic Energy. Ultrasonic energy is present in the ultrasonic cleaner reservoir (if equipped) when AUTOCLEAN/Quick Clean programs are running. Avoid putting your fingers in the bath. Ultrasonic energy can be destructive to human tissue.

Warning! Software Quality Control. The operator must follow the manufacturer's assay package insert when modifying software parameters and establishing washing or dispensing methods. **Failure to conduct quality control checks could result in erroneous test data.**



Warning! Internal Voltage. Always turn off the power switch and unplug the power supply before cleaning the outer surface of the instrument.



Warning! Potential Biohazards. Some assays or specimens may pose a biohazard. Adequate safety precautions should be taken as outlined in the assay's package insert. This hazard is noted by the symbol shown here. Always wear safety glasses and appropriate protective equipment, such as chemically resistant rubber gloves and apron.



Warning! Pinch Hazard. Some areas of the instrument or its components can present pinch hazards when the instrument is operating. Depending on the instrument or component, these areas are marked with the symbol shown here. Keep hands/fingers clear of these areas when the instrument is operating.

Precautions

The following precautions are provided to help avoid damage to the instrument:



Caution: Service. The instrument should be serviced by BioTek authorized service personnel. Only qualified technical personnel should perform troubleshooting and service procedures on internal components.

Caution: Spare Parts. Only approved spare parts should be used for maintenance. The use of unapproved spare parts and accessories may result in a loss of warranty and potentially impair instrument performance or cause damage to the instrument.

Caution: Environmental Conditions. Do not expose the instrument to temperature extremes. For proper operation, ambient temperatures should remain within the range listed in the **Specifications** section. Performance may be adversely affected if temperatures fluctuate above or below this range. Storage temperature limits are broader.

Caution: Sodium Hypochlorite. Do not expose any part of the instrument to the recommended diluted sodium hypochlorite solution (bleach) for more than 20 minutes. Prolonged contact may damage the instrument surfaces. Be certain to rinse and thoroughly wipe all surfaces.

Caution: Buffer Solution. Although many precautions have been taken to ensure that the instrument is as corrosion-proof as possible, the instrument is not sealed and liquids can seep into sensitive components. Make sure that any spilled buffer solution is wiped off the instrument. Prolonged exposure to salt solution may corrode parts of the microplate carrier, movement rail, springs, and other hardware.

Caution: Chemical Compatibility. Some chemicals may cause irreparable damage to the instrument. The following chemicals have been deemed safe for use in the instrument: buffer solutions (such as PBS), saline, surfactants, deionized water, 70% ethyl, isopropyl, or methyl alcohol, 40% formaldehyde, and 20% sodium hydroxide. Never use acetic acid, DMSO, or other organic solvents. These chemicals may cause severe damage to the instrument. Contact BioTek for more information and prior to using other questionable chemicals.

Caution: Bovine Serum Albumin. Solutions containing proteins, such as bovine serum albumin (BSA), will compromise the instrument's performance over time unless a strict maintenance protocol is adhered to. See **Maintenance** procedures regarding BSA.

Caution: Power Supply. Only use the power supply shipped with the instrument. Operate this power supply within the range of line voltages listed on it.

Caution: Disposal. This instrument contains printed circuit boards and wiring with lead solder. Dispose of the instrument according to Directive 2002/96/EC, "on waste electrical and electronic equipment (WEEE)," or local ordinances.

Caution: Warranty. Failure to follow preventive maintenance protocols may **void the warranty**.

Caution: Shipping Hardware. All shipping hardware (e.g., shipping bracket etc.) must be removed before operating the instrument and reinstalled before repackaging the instrument for shipment.

Caution: High Flow Pump Installation. DO NOT plug the High Flow vacuum pump cable into a wall outlet! Use the adapter provided with the pump to connect the pump to the accessory outlet on the back of the washer. See the ***Installation*** instructions.

Caution: Waste Sensor Port on 405 TS. (For customers who have purchased the BioStack Microplate Stacker.) Although the waste sensor port on the back of the 405 TS is the same type as the 24-VDC power connector on the back of the BioStack, if an external 24-VDC power supply is plugged into the 405 TS's port, **it will permanently damage internal components.**

Caution: Electromagnetic Environment. Per IEC 61326-2-6 it is the user's responsibility to ensure that a compatible electromagnetic environment for this instrument is provided and maintained in order that the device will perform as intended.

Caution: Electromagnetic Compatibility. Do not use this device in close proximity to sources of strong electromagnetic radiation (e.g., unshielded intentional RF sources), because these may interfere with the proper operation.

CE Mark



Based on the testing described below and information contained herein, this instrument bears the CE mark.

- **Note:** See the Declaration of Conformity for specific information.

Directive 2004/108/EC: Electromagnetic Compatibility

Emissions—Class A

The system has been type-tested by an independent, accredited testing laboratory and found to meet the requirements of EN 61326-1: Class A for Radiated Emissions and Line Conducted Emissions.

Verification of compliance was conducted to the limits and methods of EN 55011 (CISPR 11) Class A. In a domestic environment it may cause radio interference, in which case, you may need to mitigate the interference.

Immunity

The system has been type-tested by an independent, accredited testing laboratory and found to meet the requirements of EN 61326-1 and EN 61326-2-6 for Immunity.

Verification of compliance was conducted to the limits and methods of the following:

EN 61000-4-2, Electrostatic Discharge

EN 61000-4-3, Radiated EM Fields

EN 61000-4-4, Electrical Fast Transient/Burst

EN 61000-4-5, Surge Immunity

EN 61000-4-6, Conducted Disturbances from RFI

EN 61000-4-11, Voltage Dips, Short Interruptions and Variations

Directive 2006/95/EC Low Voltage (Safety)

The system has been type-tested by an independent testing laboratory and was found to meet the requirements of this Directive. Verification of compliance was conducted to the limits and methods of the following:

EN 61010-1, "Safety requirement for electrical equipment for measurement, control and laboratory use. Part 1, General requirements."

EN 61010-2-081, "Particular requirements for automatic and semi-automatic laboratory equipment for analysis and other purposes."

Directive 2002/96/EC: Waste Electrical and Electronic Equipment

Disposal Notice: This instrument contains printed circuit boards and wiring with lead solder. Dispose of the instrument according to Directive 2002/96/EC, "on waste electrical and electronic equipment (WEEE)" or local ordinances.

Directive 98/79/EC: In Vitro Diagnostics (if labeled for this use)

- Product registration with competent authorities.
- Traceability to the U.S. National Institute of Standards and Technology (NIST).

EN 61010-2-101 Particular requirements for in vitro diagnostic (IVD) medical equipment.

Electromagnetic Interference and Susceptibility

USA FCC CLASS A

RADIO AND TELEVISION INTERFERENCE

NOTE: This equipment has been tested and found to comply with the limits for a Class A digital device, pursuant to Part 15 of the FCC Rules. These limits are designed to provide reasonable protection against harmful interference when the equipment is operated in a commercial environment. This equipment generates, uses, and can radiate radio frequency energy and, if not installed and used in accordance with the instruction manual, may cause harmful interference to radio communications. Operation of this equipment in a residential area is likely to cause harmful interference, in which case the user will be required to correct the interference at their own expense.

In order to maintain compliance with FCC regulations shielded cables must be used with this equipment. Operation with non-approved equipment or unshielded cables is likely to result in interference to radio and television reception.

Canadian Department of Communications Class A

This digital apparatus does not exceed Class A limits for radio emissions from digital apparatus set out in the Radio Interference Regulations of the Canadian Department of Communications.

Le présent appareil numérique n'émet pas de bruits radioélectriques dépassant les limites applicables aux appareils numériques de la Class A prescrites dans le Règlement sur le brouillage radioélectrique édicté par le ministère des Communications du Canada.













User Safety



This device has been type-tested by an independent laboratory and found to meet the requirements of the following:

- **Underwriters Laboratories UL 61010-1** "Safety requirements for electrical equipment for measurement, control and laboratory use; Part 1: general requirements."
- **Canadian Standards Association CAN/CSA C22.2 No. 61010-1** "Safety requirements for electrical equipment for measurement, control and laboratory use; Part 1: general requirements."
- EN 61010 Standards, see CE Mark on page 89.

Safety Symbols

Some of these symbols appear on the instrument or accessories:

	Alternating current Courant alternatif Wechselstrom Corrientealterna Correntealternata		Both direct and alternating current Courant continu et courant alternatif Gleich - und Wechselstrom Corriente continua y corrientealterna Corrente continua e correntealternata
	Direct current Courant continu Gleichstrom Corriente continua Corrente continua		Earth ground terminal Borne de terre Erde (Betriebserde) Borne de tierra Terra (difunzionamento)
	On (Supply) Marche (alimentation) Ein (VerbindungmitdemNetz) Conectado Chiuso		Protective conductor terminal Borne de terre de protection Schutzleiteranschluss Borne de tierra de protección Terra diprotezione
	Off (Supply) Arrêt (alimentation) Aus (TrennungvomNetz) Desconectado Aperto (sconnessionedallaretedialimentazione)		Caution (refer to accompanying documents) Attention (voir documents d'accompagnement) AchtungsieheBegleitpapiere Atención (vease los documentosincluidos) Attenzione, consultare la doc annessa
	Warning, risk of electric shock Attention, risque de choc électrique Gefährlicheelektrischeschlag Precaución, riesgo de sacudidaeléctrica Attenzione, rischiodiscossaelettrica	 	Warning, risk of crushing or pinching Attention, risqued'écrasement et pincement Warnen, Gefahr des Zerquetschens und Klemmen Precaución, riesgo del machacamiento y sejeción Attenzione, rischiodischiacciareedintrappolarsi
	Warning, hot surface Attention, surface chaude Warnen, heiÙeOberflÙache Precaución, superficiecaliente Attenzione, superficiecalda		Warning, potential biohazards Attention, risquesbiologiquespotentiels Warnung! MoeglichebiologischeGiftstoffe Atención, riesgosbiológicos Attenzione, rischiobiologico

	<p>In vitro diagnostic medical device Dispositif médical de diagnostic in vitro Medizinisches In-Vitro-Diagnostikum Dispositivo médico de diagnóstico in vitro Dispositivo medico diagnostico in vitro</p>		<p>Separate collection for electrical and electronic equipment Les équipements électriques et électroniques font l'objet d'une collecte sélective Getrennte Sammlung von Elektro- und Elektronikgeräten Recogida selectiva de aparatos eléctricos y electrónicos Raccolta separata delle apparecchiature elettriche ed elettroniche</p>
	<p>Consult instructions for use Consulter la notice d'emploi Gebrauchsanweisung beachten Consultar las instrucciones de uso Consultare le istruzioni per uso</p>		

Troubleshooting

Error recovery:

First Response: Run a System Test (restart the instrument) to give the instrument an opportunity to restore its initial settings and communication capability.

LHC Users: Reboot your Computer and Instrument: When you cannot run a system test, e.g. LHC is not responding, or when running a system test doesn't resolve the issue, turn off your computer and 405 TS, check all the cabling, i.e. make sure your USB cable is in good condition and is properly connected to the PC and instrument, and then, power them on. This should refresh the devices and reset communication parameters.

Error Codes

To find a specific error code:

- Software Error Codes (6000-6100) - protocol errors
- System Error Codes (0000-A500) - hardware errors

Most error conditions generate an error message that is displayed on the computer screen or keypad.

6045	Serial write error
------	--------------------

LHC Users: A potentially common error, especially when using the Predefined Protocols, a "serial write" error, is easily fixed by correcting the COM port setting defined in the protocol.

810D	To communicate, instrument must be at main menu/Home screen.
------	--

LHC Users: Similarly, the 810D message appears when the instrument is busy, for example when AutoPrime is running. The LHC can only talk to the instrument when its Home screen is displayed. Press the **Stop** button, if desired, to end the current process and reestablish communication with the LHC.

BioStack Errors: To recover from a BioStack error, remove the plate from the BioStack's tray, if applicable, and Home the stacker using the alignment utility: select **Instrument>Next>BioStack** from the Home screen. Press **BioStack Alignment** and then **Home**.



Technical Note: Only one of the two communication ports (COM port) on the instrument can be used at a time. They cannot be used simultaneously. You

can use USB to connect the 405 TS to the computer or the RS232 serial port to connect to a BioStack or similar robotic device. But you cannot use both ports simultaneously, i.e. make sure only one cable is plugged in at a time.

Washer Problems

Review these suggestions to correct problems your washer is having:

- Vacuum Pump Problems on page 102
- Fluid Aspiration on the next page
- Fluid Delivery on page 98
- Fluid Leakage on page 100
- Washer Manifold Movement on page 101

Microplate Carrier Movement

Problem	Possible Cause	What To Do
Aspiration tubes not entering wells correctly.	Microplate not properly seated or strips not level.	Reseat microplate in carrier or strips in holder. Make sure the carrier is clean. Try a different microplate or strip holder. If the problem is unresolved, the carrier may have to be realigned. Contact BioTek TAC.
	Aspirate tubes position is too wide for a movement.	Change the horizontal, X- or Y-axis aspirate position in the protocol.
	Aspirate tubes bent.	Contact BioTek TAC.
Loud, annoying noise during operation.	Plate carrier is rubbing against glide strip.	Thoroughly clean the microplate carrier and exterior surface as recommended in the maintenance procedure.
384-well plates not properly washed.	Microplate carrier not moving correctly in the Y-axis.	Clean the plate carrier system. If problems persist, contact TAC for assistance cleaning the carrier transport arm.

Problem	Possible Cause	What To Do
Uneven performance.	Plate carrier leveling feet damaged.	Replace plate carrier: contact BioTek TAC for assistance. Note: "Q" model washers with Verify™ Technology must recalibrate the Verify test plate after installing the new carrier.

Fluid Aspiration

Problem	Possible Cause	What To Do
Poor or uneven aspiration.	Insufficient or no vacuum.	Firmly seat the waste bottle covers. Ensure tubing is connected properly.
		Check all external tubing and in-line filter for kinks or clogs. If you are using an in-line vacuum filter, it may need to be replaced.
		With the vacuum pump on, remove the vacuum pump tubing from the back of the instrument. Put your finger over the port; if there is no vacuum, contact BioTek TAC.
	Clogged aspiration tubes on the washer manifold.	Remove and clean the washer manifold
		Make sure the microplate carrier is level and the waste valve is not touching the bench.
	Aspirate height adjustment too high or too low.	Change the aspiration height (Z-axis position) in the protocol. Similarly, make sure the Magnet Height offset is disabled or not too high.
	Vacuum pump failure.	Contact BioTek TAC.

Problem	Possible Cause	What To Do
Uneven aspiration of water buffer. Some wells left full.	No surfactant in the buffer, such as Tween [®] 20.	Add surfactant to the buffer. If this is not possible, continue below.
	Insufficient vacuum.	BioTek offers a high-flow pump for assays using only water for the wash fluid. Contact BioTek for more information.
	Protocol settings not optimized.	Optimize protocols to improve evacuation
	Aspiration tubes not properly positioned horizontally in wells.	If none of the tubes are bent, try adjusting the horizontal aspirate position (X-/Y-axis) in the protocol.
	Microplate not level in carrier, or strips not level in holder.	Reseat microplate in carrier or strips in holder. Make sure the carrier is clean. Try a different microplate or strip holder. If the problem is unresolved, the carrier may have to be realigned. Contact BioTek TAC.
Too much residual left in wells after aspiration.	Clogged vacuum filter.	If you are using an in-line vacuum filter (PN 49943), the filter may need to be cleaned or replaced.
	Waste bottle cover not properly sealed or fittings not properly connected.	Firmly seat the waste bottle stopper. Make sure tubing is connected properly.
	Manifold out of alignment or not moving freely.	Check for obstructions. If none are found, contact BioTek TAC.
	Protocol requires optimization.	Optimize protocols to improve evacuation.
	Aspirate tubes are bent.	Contact BioTek TAC.

Fluid Delivery

Problem	Possible Cause	What To Do
Unable to dispense fluid.	Inlet tube not connected.	Make sure all tubing is connected properly. Check all external tubing for kinks or clogs.
	Clogged fluid filter.	Clean the fluid filter inside the supply bottle.
	Clogged valve	Create a protocol with several small primes, e.g. 10 mL, to try to unclog valve.
	Clogged dispense tubes on the washer manifold.	Remove and clean the washer manifold
	No wash or rinse fluid.	Fill bottles with appropriate fluid. Ensure bottles are clean and do not contain particles or organic material.
Unable to dispense fluid.	System not primed. Large air pockets in tubing.	Run W-DAY_RINSE.
	Insufficient suction, clogged tubing, or faulty valve.	Perform Washer Maintenance; If the problem persists, contact BioTek TAC.
Plate overfills (floods).	Dispense height too high. The aspirate tubes are too far above the wells to prevent overflow.	Lower the dispense height (Z-axis position) in the protocol.
	Dispense flow rate too low.	Define a higher dispense Flow Rate in the protocol.
	Cell wash flow rate 1 or 2 is used with 384-well plates.	Specify a non-CW dispense Flow Rate when using 384-well plates.
	Aspiration tubes hit bottom of trough during Prime or Maintenance.	Manifold may not be properly seated or mounted. Contact BioTek TAC.
	In-line vacuum filter plugged.	Replace or remove the in-line vacuum filter.

Problem	Possible Cause	What To Do
	Loose covers on waste bottles.	Firmly tighten waste bottle covers.
	Dispense rate too fast for volume selected.	Specify slower dispense Flow Rate or lower volume.
	Faulty vacuum pump.	Contact BioTek TAC.
	Insufficient or no vacuum.	Firmly seat the waste bottle covers. Check all external tubing for kinks or clogs. When the program begins, you should be able to hear the vacuum pump turn on. If it is not turning on, contact BioTek TAC. If the vacuum pump turns on, remove the vacuum tubing from the back of the instrument and put your finger over the port. If there is no vacuum, contact BioTek TAC.
Uneven dispensing of fluid; wells not filled.	Clogged dispense tubes on the washer manifold.	Remove and clean the washer manifold
	Manifold or tubing not adequately primed.	Run W-DAY_RINSE once or twice.
	Dispense flow rate too low. Flow rate 1 or 2 CW is used with 384-well plates.	Define a higher dispense Flow Rate.
	Microplate aspiration height adjustment too high or too low.	Change the aspirate height (Z-axis position) in the protocol.

Fluid Leakage

Problem	Possible Cause	What To Do
Fluid leaking from manifold.	Defective seals.	Contact BioTek TAC
	Aspiration tubes only: vacuum too low.	<p>Check waste connector tubes; make sure they are properly connected.</p> <p>If you are using an in-line vacuum filter, check the filter for clogging, and replace if necessary.</p> <p>Check seal of waste bottle covers.</p> <p>Check for air leaks in the waste tubing and bottles.</p> <p>Use a slower Aspiration Travel Rate.</p> <p>Direct Drain waste system users: if the aspirate manifold is dripping at the end of a run, add a Prime step to the protocol to precede the wash. This will turn on the vacuum pump and keep it running during the protocol to prevent the manifold from dripping on the plate.</p>
	Uneven (not level) surface.	Make sure the washer sits on a perfectly level surface.
Fluid leaking from underneath the instrument.	Defective tubing connector or inlet tubing.	Contact BioTek TAC.
	Leaking valve.	Contact BioTek TAC.
Fluid leaking from external tubing connector.	Defective connector.	Replace connector.
	Worn tubing.	Replace tubing or cut back tubing one inch (to remove worn section).
	Worn seal (inlet or vacuum fitting).	Replace filter or seal.

Washer Manifold Movement

Problem	Possible Cause	What To Do
Manifold position error.	Manifold movement is blocked.	Check orientation of microplate; A1 should be in the left rear corner of the plate carrier as you face the instrument. Check for and remove any obstructions. Ensure the manifold is installed properly.
	Incorrect manifold selected.	Make sure the washer manifold setting matches the installed manifold (96-, 192--tube). LHC: Tools>Instrument Utilities>Washer>Manifold Selection. Touch screen: Instrument>Options>Manifold Selection

Vacuum Pump Problems

Problem	Possible Cause	What To Do	
Vacuum pump does not start, or shakes when turned on.	Vacuum pump is not turned on.	Flip the switch on the side of the vacuum pump to turn it on.	
	Vacuum pump accessory cable not installed correctly.	Plug the vacuum pump accessory cable into the back of the instrument, Accessory Outlet.	
	Too much residual vacuum force for pump.	Release the vacuum by loosening the waste bottle stopper. Reconnect and start again.	
	Blown fuse in accessory outlet.		Plug the vacuum pump accessory cable into the back of the instrument, Accessory Outlet, not into a wall outlet.
			Increase vacuum dissipation delay. LHC: Tools>Instrument Utilities>Vacuum Dissipation Delay. Touch screen: Instrument>Options>Advanced Settings
		Replace fuse (PN 46055), Replace the Vacuum Pump Fuse	
Repeated blown fuses.	Vacuum Dissipate Delay is set too low for the volume of the waste bottle.	See above. If not enough time is allowed for the vacuum to dissipate, the pump will try to start while it is under a vacuum. The pump draws excessive current and blows the fuse.	
	Pump has been flooded.	Remove the head from the pump and inspect it for corrosion, crystalline buildup or liquid. Contact BioTek TAC for information on pump rebuilding kits.	

Specifications and Part Numbers

For your convenience this section contains commonly sought reference information. Consult the operator's manual on CD for more complete information.

Physical Specifications	104
Performance Specifications	105
Package Contents	107
Optional Accessories	110

Physical Specifications

Labware	
Microplates	96-well, 384-well that comply with SBS microplate standards 1-2004, 2-2004, 3-2004, and 4-2004.
Microstrips	1 x 8, 1 x 12
Microwells	Flat, round, "V" bottom

Hardware & Environmental	
User Interface	5.7" touch screen
Power Supply	The instrument uses two internal power supplies: 24-volt 60 watt and 48-volt 60 watt. These supplies are compatible with 100-240 V~; 50-60 Hz.
Accessory Outlet	≤ 5.0 A, used for vacuum pump
Dimensions (W x D x H)	14 x 17 x 10 inches (36 cm x 43 cm x 25 cm)
Weight (≤)	32 lb (14.5 kg)/36 lb with Buffer Switching (16.3 kg)
Operating Conditions	10° - 40°C (50° - 104°F)
Relative Humidity	The instrument should be operated in a non-condensing humid environment having a maximum relative humidity of 80% at temperatures up to 31°C decreasing linearly to 50% relative humidity at 40°C.

Manifold Type	
96-tube	Single or Dual manifold with 96 sets of aspirate and dispense tubes arranged in an 8x12 array. Single manifolds can only process 96-well microplates; dual manifolds can process 96- and 384-well plates.
192-tube	Dual manifold with 192 sets of aspirate and dispense tubes arranged in a 16 x 12 array can only process 384-well plates.

Waste bottle volume	4, 10, or 20 liters, depending on the accessory package, (2 bottles, one with sensor)
Supply bottle volume	2 4L or 10L bottles (4 bottles w/ Buffer Switching)

Performance Specifications

Average Residual Volume (Evacuation Efficiency)	
96-Tube Manifold (Single and Dual)	Average residual volume in the microwells is $\leq 2 \mu\text{L}$ per well after a 3-cycle wash, when 300 μL of deionized water with 0.1% Tween 20 [®] , or buffer equivalent, is dispensed per well into a Costar [®] 96-well flat-bottom plate. The aspirate height adjustment is optimized for the plate prior to testing.
192-Tube Manifold	Average residual volume in the microwells is $\leq 2 \mu\text{L}$ per well after a 3-cycle wash, when 100 μL of deionized water with 0.1% Tween 20, or buffer equivalent, is dispensed per well into a Costar 384-well flat-bottom plate. The aspirate height adjustment is optimized for the plate prior to testing.

Vacuum Filtration Evacuation Efficiency	
96-Well Filter Plates	Average increased weight of the plate is ≤ 1.2 grams after dispensing 300 μL of deionized water per well into a Millipore [®] MSHVN4450 96-well 0.45 μm plates (PN 98258) and vacuum aspirated for 30 seconds and blotted on a paper towel.
384-Well Filter Plates	Average increased weight of the plate is ≤ 4.0 grams after dispensing 80 μL of deionized water per well into a Millipore [®] MZFCN0W10 384-well 1.2 μm plates (PN 98287) and vacuum aspirated for 10 seconds and blotted on a paper towel.

Dispense Precision	
96-Tube Manifold	$\leq 3.0\%$ CV when dispensing 300 μL per well of deionized water with 0.1% Tween 20, with FD&C #1 blue dye at rate 6 into a Costar 96-well flat-bottomed plate. The absorbance of the solution is read at 630 nm and 450 nm reference.

Dispense Precision	
192-Tube Manifold	≤ 4.0% CV when dispensing 80 µL per well of deionized water with 0.1% Tween 20, with FD&C #1 blue dye at rate 7 into a Costar 384-well flat-bottomed plate. The absorbance of the solution is read at 630 nm and 450 nm reference.

Verify™ Clog Detection Technology	
Timing	A Verify test shall be completed in less than 5 minutes from initiation until test results are displayed.
Performance	The Verify level sensor measurement shall have a repeatability standard deviation of $\sigma_{\text{measurement}} < 0.14 \text{ mm}$ (9.0 µL for 8X8 square well plate), where the $\sigma_{\text{measurement}}$ applies to a relative volume measurement, i.e. the delta between two volumes.

Package Contents

- Part numbers and package contents are subject to change and vary according to instrument model. Please contact BioTek Customer Care if you have any questions.

Description	PN
Power cord (part numbers vary by country of use)	Varies
USB cable (USB Virtual COM Port Driver Software & instructions)	75108
Microplate carrier	Varies
Mist shield	1172017
Accessory kit	1170012
Stylus: for cleaning washer manifold aspirate tubes	7102108
Stylus: for cleaning washer manifold tubes	2872304
Stylus: for cleaning 192-tube dispense manifold	7102139
Shipping bracket - model dependent	7102138 1242018 or 1242021 1242032 and 1242019
Hex wrench: 9/64"	48434
Spare fuses (5)	46055
Verify Test Plate for "Q" models only	01588
Manifold Stop Screw Kit (Required for Vacuum Filtration, 384-Well PCR processing and magnetic bead assays.)	1170011
405™ TS Getting Started Guide (and operator's manual on USB - PN 1171039)	1171009

- Some components are model specific, they ship only with certain instrument models.

Waste and Dispense System Accessories

Part Number	Description	
Standard Vacuum Pump Systems:		
1170530	Complete Dispense/Waste System 115V/230V, 4L Bottles, including:	
	7100746	Waste: 4L bottles (2, one with sensor)
	1170529	Dispense: 4L bottles with filters (2)
7100746	Complete Waste System 115V/230V, 4L Bottles, including:	
	7100543	Waste: 4L bottles (2, one with sensor)
	7103024	Vacuum pump 115V/230V
1170535	Complete Dispense/Waste System 115V/230V, 10L Bottles, including:	
	1170534	Waste: 10L bottle (1), 4L bottle with sensor (1)
	1170528	Dispense: 10L bottles (2)
1170534	Complete Waste System 115V/230V, 10L Bottles, including:	
	7100582	Waste: 10L bottle (1), 4L bottle with sensor
	7103024	Vacuum pump 115V/230V
High Flow Vacuum Pump Systems:		
1170532	Complete Dispense/High Flow Waste System 115V/230V, 4L Bottles, including:	
	7100753	Waste: 4L bottles (2, one with sensor)
	1170529	Dispense: 4L bottles with filters (2)
7100753	Complete High Flow Waste System 115V/230V, 4L Bottles, including:	
	7100543	Waste: 4L bottles (2, one with sensor)
	7100754	High-flow vacuum pump 115V/230V
1170533	Complete Dispense/High Flow Waste System 115V/230V, 10L Bottles, including:	
	1170531	Waste: 10L bottle (1), 4L bottle with sensor

Part Number	Description	
	1170528	Dispense: 10L bottles (2)
1170531	Complete High Flow Waste System 115V/230V, 10L Bottles, including:	
	7100754	High-flow vacuum pump 115V/230V
	7100582	Waste: 10L bottle (1), 4L bottle with sensor (1)
Direct Drain Vacuum Pump Systems:		
1170536	Complete Dispense/Direct Drain Waste System 115V/230V, 4L Bottles, including:	
	1170529	Dispense: 4L bottles with filters (2)
	Direct drain vacuum pump & tubing	
1170537	Complete Dispense/Direct Drain Waste System 115V/230V, 10L Bottles, including:	
	1170528	Dispense: 10L bottles with filters (2)
	Direct drain vacuum pump & tubing	
Notes:		
1) Models with Buffer Switching receive a dispense system. Only a waste system must be ordered separately.		
2) High-flow waste system may be necessary for 384-well washing with buffers not containing surfactant.		
3) Direct Drain Waste System: use restricted to 96-tube single manifold models (i.e. 405 TS).		

Optional Accessories

General Instrument Accessories

Description		PN
BioTek liquid testing solutions for instrument qualification tests	Wetting Agent	7773002
	Blue Test Dye	7773001
Liquid Handling Control™ Software		LHC2
BioStack™ Microplate Stacker and integration kit		Biostack
Installation-Operational-Performance Qualification (IQ-OQ-PQ) package		1170522

Washer Accessories

Magnetic Bead Assay Accessories

Accessory	PN
Magnets:	
384-well Flat Magnet	7103017
384-well Ring Magnet	7102215
96-well Flat Magnet	7103016
96-well Ring Magnet	7102216

Vacuum Filtration Kit

Description	PN
-- 96-well Only	1170008
-- 96- and 384-well	1170009

Verify™ Technology Accessories

Description	PN
Verify Test Plate Replacement Kit	1240001

Miscellaneous Accessories

Description	PN
96-tube Manifold Kit - Replacement kit for 405 Select to support 384-well non-surfactant buffer washing (Tube-in-Tube).	1172046S
96-Tube 7-Degree Dual Manifold Upgrade Kit - Additional manifold for 405 HT for 96-well washing. (Tube-in-Tube)	1170010
4L Dispense Bottle w/filter	1173031
Cap for 4L Dispense Bottle w/filter	1173003
10L Dispense Bottle w/filter	1173000
Cap for 10L Dispense Bottle w/filter	1173002
Dispense Tubing Set - 1 Buffer	7100538
Dispense Tubing Set - 4 Buffers (For Buffer Switching models.)	7100537
4L Waste Bottle	7100534
Cap for Waste Bottle, 4L (Also fits 10L and 20L bottles.)	7100531
Waste Bottle with Level Sensing, 4L	7100542
Cap for Waste Bottle with Level Sensing, 4L	7100544
10L Waste Bottle and Tubing	7100557
20L Waste Bottle and Tubing	7100556
Waste Tubing Set	7100533
Vacuum Line Filter for Waste Tubing	48294
Vacuum Gauge/Regulator (For use with house vacuum.)	4030551
Silencing Muffler for Vacuum Pump (For use with P/N 7103024 pump.)	01113
Fluid filter for dispense bottles (does not include stainless steel adaptor 1172031)	01310

Index

<hr/> 1 <hr/>	
192-Tube Manifold.....	69, 105
<hr/> 3 <hr/>	
384-well plates	
Manifold selection.....	69
<hr/> 9 <hr/>	
96-Tube Manifold.....	69, 105
<hr/> A <hr/>	
Accessories.....	110
Accessory Outlet.....	104
Aspirate fluid	
how to delay.....	54
Uneven aspiration.....	97
Assays	
Biomagnetic separation.....	56
Bottom/vacuum filtration.....	64
Cellular.....	51
AutoClean.....	80
AutoPrime.....	70, 79
Washer.....	69
AutoPrime Interval.....	70
Average Residual Volume.....	105
<hr/> B <hr/>	
BioStack	
Create a protocol.....	49
How to configure/operate.....	47
Use.....	49
BioStack errors.....	94
BioTek's Customer Resource Center...	7
BioTek's Ultrasonic Advantage.....	80
Bottles	
Clean filter.....	83
Connection.....	14
BSA.....	80, 82
Buffer Switching	
installation.....	17
<hr/> C <hr/>	
Cell Wash.....	51-52
Strategy to preserve cells.....	53
Change	
Fluids.....	52
Cleaning.....	80
Removing proteins.....	82
COM Port.....	22, 39
CW+ Control.....	51
<hr/> D <hr/>	
Delay after Dispense.....	54
Delay Aspiration.....	54
Direct Drain.....	100
Dispense Precision.....	105
Dripping manifold.....	100
<hr/> E <hr/>	
Error codes.....	94
Evacuation Efficiency.....	105
<hr/> F <hr/>	
Flow Detection.....	69
Fluid Detection.....	69
Fluid Leaking.....	100
Fluid Supply	
Clean filter.....	83
washer.....	17
<hr/> G <hr/>	
General Settings.....	23
<hr/> H <hr/>	
Hardware.....	104

V

Vacuum	
Low	96
Vacuum Dissipate	22
Vacuum on based on volume	54
Valve module	
installation	17

W

Wash	
Gentle, cell wash	51
Magnetic beads	56
Polystyrene beads	64
Washer	
Fixing problems	95
Protocol parameters listing	43
Washer Prime step	38
Washer Settings	69
Waste system	
Installation	15
sensor	69

405 TS/LS Chemical Compatibility Chart

Table 1: Material/Where Used List

#	Material	Where Used
1	304 Stainless Steel	Inlet screen, feeder tube to manifold, vacuum switch
2	316 Stainless Steel	Dispense and aspirate tubes, feeder tube to manifold, spring in bottle fittings
3	Acetal	Vacuum filtration plug
4	Aluminum (anodized)	Microplate carrier, vacuum filtration carrier grill and retainer
5	CPVC (Chlorinated Polyvinyl chloride)	Manifold, vacuum filtration carrier
6	Nylon	Inlet fitting, vacuum switch adjustment screw, carrier leveling feet
7	PTFE (polytetrafluoroethylene) Teflon	Optional check valves (PN: 68098) for fluid pump, direct drain pump, fluid path
8	EPDM (Ethylene Propylene)	Inlet valve, vacuum filtration 3-way valves, vacuum switch diaphragm
9	Neoprene	Manifold channel-end seals
10	PPO (polyphenylene Oxide) Noryl®	Vacuum switch internal disc
11	Polycarbonate	Vacuum switch body, Vacuum filtration intermediate waste bottle, direct drain intermediate waste bottle
12	Polyethylene	Buffer bottle
13	Polypropylene	Outlet fitting, fittings in bottles, inline fittings, float ball, bottle caps, vacuum filtration module bulkhead fittings
14	Polystyrene	Flow sensor, mist shield, assay plates
15	PVC (Polyvinyl chloride)	Inlet valve, waste sensor, flow sensor ball retainer, waste tubing, vacuum filtration plug
16	PPS (polyphenylenesulfide) Ryton®	Fluid pump, vacuum filtration plug, inlet valve (serial # less than 207137)
17	Thermoplastic elastomer Santoprene®	Fluid pump check valves
18	Silicone	Inlet tubing, outlet tubing, o-rings, vacuum filtration carrier gasket, vacuum filtration module tubing
19	Ultem (polyetherimide)	Outlet valve, CW inlet valve, vacuum filtration module valves
20	Viton	Outlet valve, CW inlet valve

Table 2: Chemical Compatibility Ratings

Key	1	2	3	4	5	6	7	8	9	10	11	12	13	14	15	16	17	18	19	20
	304 S. Steel	316 S. Steel	Acetal	Aluminum	CPVC	Nylon	PTFE Teflon	EPDM	Neoprene	PPO (Noryl)	Polycarbon.	Polyethylene	Polypropyl.	Polystyrene	PVC	PPS Ryton	Santoprene	Silicone	Ultem	Viton
Chemical	1	2	3	4	5	6	7	8	9	10	11	12	13	14	15	16	17	18	19	20
Acetic Acid, 5%	D	A	D	B	A	D	A	ND	B	A	A	A	A	D	D	A	C	C	A	B
Acetic Anhydride	B	A	D	A	D	A	A	A	B	D	D	C	B	D	D	A	A	A	ND	D
Acetonitrile	ND	A	ND	B	D	A	A	C	ND	ND	D	A	A	D	D	A	ND	D	D	D
Ammonia 10%	A	A	D	A	A	A	A	ND	A	A	D	N	A	B	B	A	A	D	D	D
Benzyl Alcohol	B	B	A	B	A	B	A	B	C	D	ND	A	A	D	D	A	A	A	ND	A
Chloroform	A	A	A	B	D	A	A	D	D	D	D	C	D	D	A	D	D	D	A	A
Detergents 1%	A	A	A	B	A	A	A	A	A	A	A	A	A	A	A	A	B	A	A	A
Dimethylformamide	A	B	D	A	D	A	A	B	D	D	D	C	A	D	D	A	D	A	ND	C
DMSO (Dimethylsulfoxide)	ND	A	ND	A	D	A	A	B	ND	ND	D	A	A	D	D	A	D	C	D	D
Ethyl Alcohol 70%	A	A	A	A	B	A	A	A	A	A	B	B	A	A	B	A	B	B	A	B
Ethylene Oxide	B	B	D	D	C	D	A	C	D	A	C	A	D	C	C	D	ND	A	ND	C
Formaldehyde 37%	A	A	A	B	A	A	A	A	B	A	A	D	A	ND	A	A	ND	C	A	A
Hexane	A	A	A	A	B	B	A	D	B	B	D	A	B	D	B	A	ND	D	A	A
Hydrochloric Acid 20%	D	D	C	D	A	D	A	A	C	B	B	A	B	C	A	D	A	D	A	A
Hydrofluoric Acid 20%	D	D	D	D	C	C	A	C	B	C	D	A	A	ND	B	A	A	D	ND	A
Hydrogen Peroxide 10%	B	B	D	A	A	A	A	A	B	A	A	A	A	A	A	C	ND	A	A	A
Isopropyl Alcohol 70%	B	A	A	A	B	D	A	A	B	A	A	B	A	A	B	A	ND	A	A	A
Methyl Alcohol 70%	A	A	A	A	A	B	A	A	A	A	B	A	A	ND	A	A	B	A	A	A
Methylene Chloride	B	B	B	C	D	C	A	ND	D	D	D	D	B	D	D	A	D	D	D	B
Phosphoric Acid >40%	D	D	D	C	A	B	A	A	B	A	A	A	A	B	B	A	A	C	A	A
Propylene Glycol	B	B	B	B	C	A	A	ND	C	ND	B	A	A	A	C	A	ND	A	ND	A
Sodium Chlorate	A	B	A	C	A	D	A	ND	A	A	A	N	A	ND	A	A	A	C	ND	A
Sodium Hydroxide 20%	B	B	A	D	A	A	A	B	B	A	A	A	A	A	A	A	ND	A	A	A
Sodium Hypochlorite <20%	C	C	D	D	A	D	A	B	C	A	C	A	A	A	A	C	ND	B	B	A
Sodium Hypochlorite 0.5%	B	B	ND	D	A	ND	A	B	C	ND	C	A	A	A	A	C	ND	B	A	A
Sulfuric Acid <10%	D	B	D	B	A	A	A	A	B	A	A	A	A	A	A	A	A	C	A	A
Trichloroethylene	B	B	D	D	D	C	A	ND	D	D	ND	D	C	D	D	A	D	D	D	A
Virkon 10%	ND	A	ND	D	A	A	ND	A	ND	ND	A	A	A	A	A	A	ND	A	ND	A

This ratings information was obtained from several reputable sources and our own experience at BioTek, but your experience may differ due to variations in concentration, temperature, and other factors. Consult the reagent/solvent manufacturer before use to verify its compatibility with instrument components.

405 TS Customer Training Guide

Instrument

Hardware

- Review flow routing and tubing connection for Supply and Waste (page 14)
- Review Mist Shield installation and cleaning
- Show location of washer aspirate/dispense tubes, describe method of operation and manifold design
- Show location and function:
 - priming trough
 - carrier
 - vacuum pump outlet
 - fuse and describe how to replace it
- Review ports:
 - USB
 - Vacuum Filtration
 - waste monitor
- Demonstrate Verify Technology (page 34)
- Review Chemical Compatibility

Onboard Software

- Show startup and priming procedure
- Show **Quick** options:
 - Prime
 - Wash
 - Clean: Sonicate Manifold
- Select and run a protocol (page 39)
- Create a protocol (page 32):
 - Wash
 - Aspirate
 - Dispense
 - Soak/Shake
 - BioStack (page 49)
- Show how to use **Align** utility
- Explain/recommend AutoPrime (page 70)
- Review end of day procedures

BioStack Interface

As applicable

- Alignment kit, 90 or 0, or -90 degree wrist, 50-plate stacks (if applicable)
- Enable BioStack
- Align gripper/claw
- Potential issues with non-SBS compliant microplates; microplate stack adjustment
- Demonstrate operation, instrument control
 - Instrument control - must create a protocol (page 49)
 - LHC Control
- Settings/Restack

LHC Software

- Show how to establish communication
- Review the options in the Target Instrument Settings
- Create and run a simple protocol
- Review the Instrument Utilities dialog options

Preventive Maintenance

- Recommended maintenance schedule (page 77)
- Cleaning in-bottle filter (page 83)
- Review programs:
 - Day Rinse
 - Overnight Loop
 - Rinse and Soak
 - Long Shutdown
- Decontamination
- Manifold cleaning procedures
 - Stylus manifold
- Carrier cleaning procedures

Special Applications

As applicable

- Cell wash assays: define a protocol (page 51)
- Magnetic bead assays: review accessories; Magnet Adapter Height setting (page 56)
- Vacuum filtration assays: review accessories; enable module; Plate Carrier setting; define a protocol (page 64)

Exercises

As applicable

- Create a protocol for:
 - ELISA
 - BioStack
- Run a Quick Wash:
 - Buffer: D
 - Cycles: 2
 - Volume: 250 μ L

Reference Material

- 405 TS Operator's Manual (on CD/USB stick)
- Touch screen Help
- LHC Help
- BioStack Operator's Manual

